



**FERUTAL**  
UTENSILERIA

Alte di Montecchio Maggiore (Vi) - Viale P. Ceccato, 66/72  
Telefono 0444602661 - e-mail: ferutal@ferutal.it

# Easy Line

Comand Tool annual promotions

con **NUOVI PRODOTTI**

**PLANET**  
system

**ModulSTAR**  
System

**ModulTURN**  
System

**25**  
**PROMO**



*finest metalworking solutions*

SEMPLICE COMPATTO FLESSIBILE

**SISTEMA DI CARICO GIREVOLE**  
su uno o più anelli sovrapposti  
per **PALLETS** e **ATTREZZATURE**

*Rotary Loading System with one or more overlapped rings for pallets and equipment*

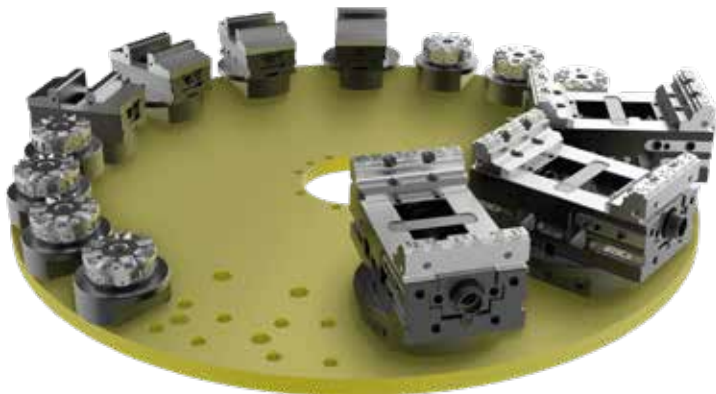

**BRACCIO ROBOTICO**  
**SCARA - COMAND TOOL**

*Braccio robotico di precisione con capacità di sollevamento di 15 kg  
Precision robot arm with 15 kg lifting capacity*



## VANTAGGI / KEY BENEFITS

**RIDUZIONE TEMPO**  
**NEL CAMBIO PEZZI**

*Eliminate downtime between part changes*

**ACCESSO FRONTALE**  
**PER CARICO - SCARICO**

*Convenient front access for loading and unloading*

**POSIZIONAMENTO LATERALE**  
**SENZA OSTACOLARE LA M.U.**

*Side by side positioning for complete machine tool access*

**PLUG and PLAY**  
**Collegamento rapido**

*Quick connection to the machine*

**SMART CONTROL**  
**Monitor Integrato o Palmare**

*Choose between Integrated Monitor or Teach Pendant*

**SPACE SAVER**  
**Dimensioni: 1000 x 2000 mm**

*Standard dimensions: 1000 x 2000 mm*

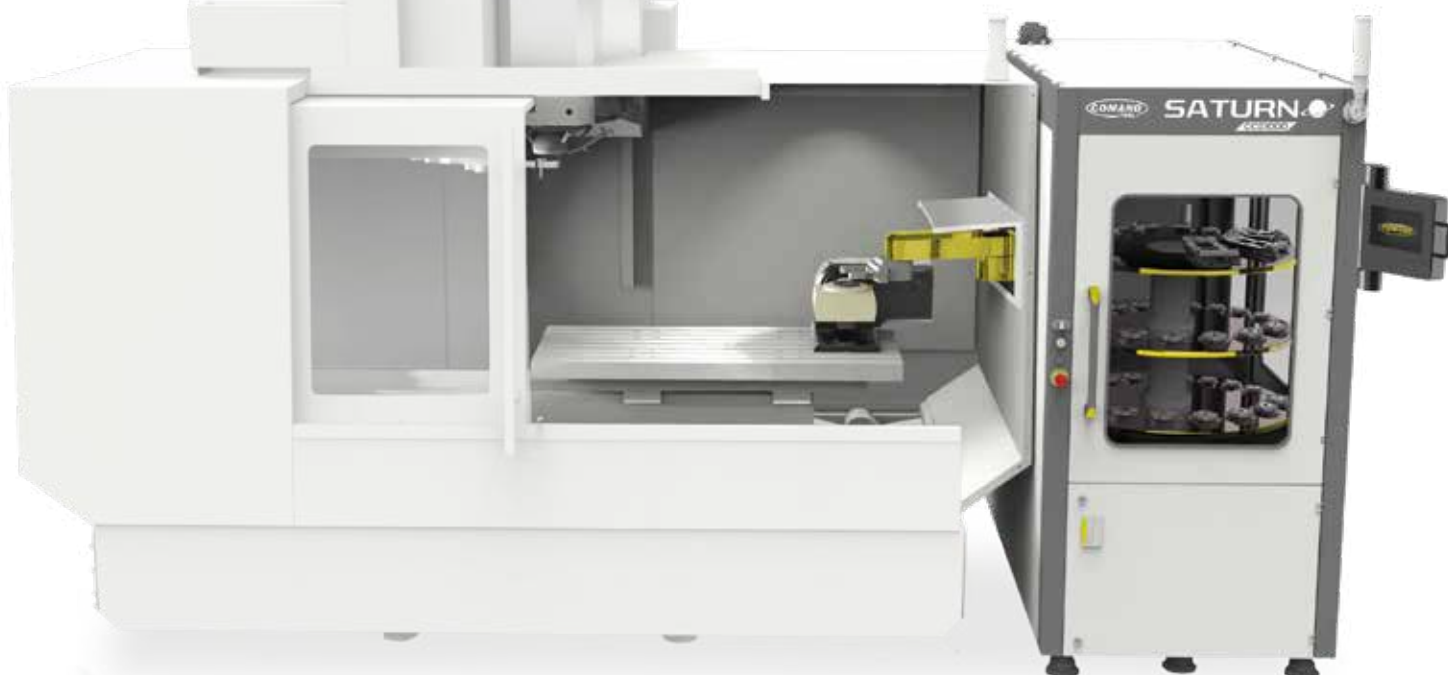

Sistema di Tornitura Interna Modulare / Internal Turning Modular System

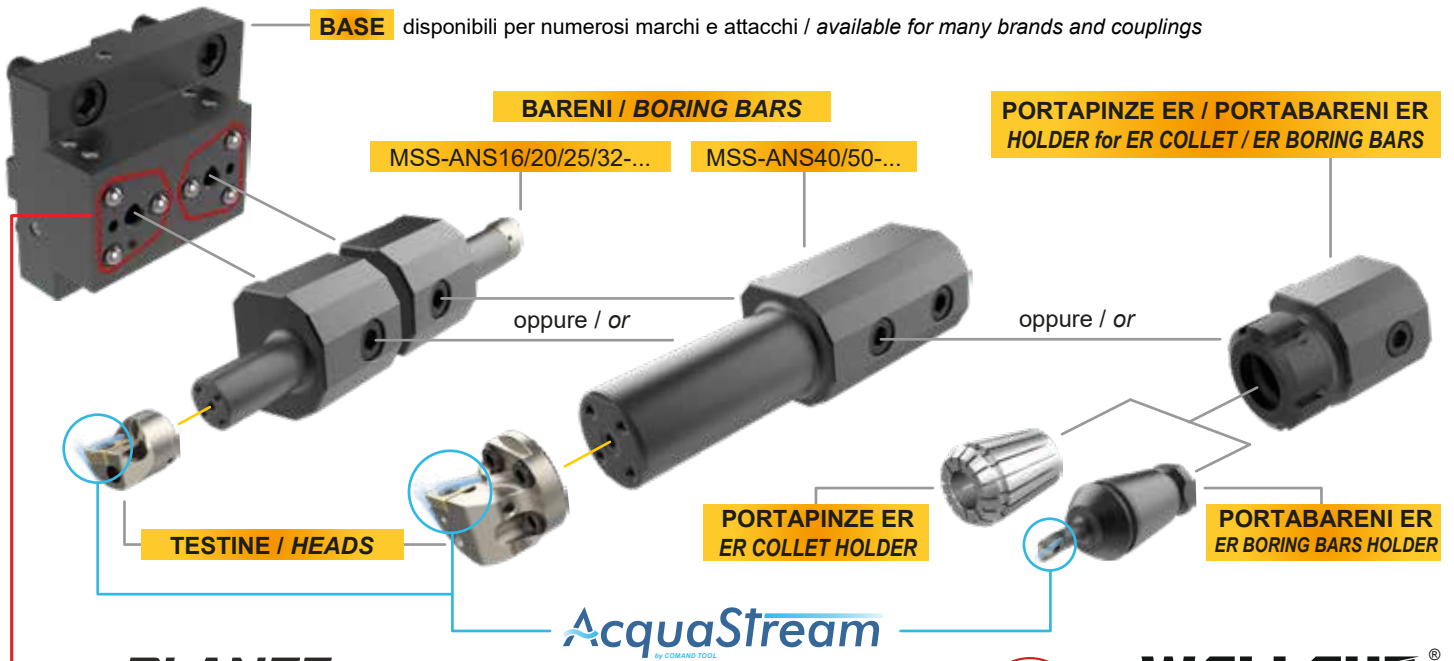

AcquaStream  
by COMAND TOOL



**WALLCUT**<sup>®</sup>  
adaptive contact technology

- **SISTEMA DI POSIZIONAMENTO A 3 SFERE**  
THREE CONTACT POINT TOOL ALIGNMENT  
FOR ACCURATE POSITIONING
- **UNA SOLA VITA PER CAMBIO RAPIDISSIMO**  
SINGLE SCREW TOOL CHANGEOVER
- **SOSTITUISCI GLI UTENSILI SENZA MAI PERDERE L'ALLINEAMENTO**  
NEVER LOSE ALIGNMENT DURING  
TOOL CHANGEOVER
- **SCEGLI L'UTENSILE PIÙ ADATTO ALLA TUA LAVORAZIONE**  
CHOOSE THE MOST SUITABLE TOOL  
FOR YOUR MACHINING

- **EFFICIENTE SISTEMA REFRIGERANTE**  
HIGHLY EFFICIENT HP COOLANT FLOW
- **ALTA PRESSIONE, TESTATA FINO A 150 BAR**  
HIGH PRESSURE TESTED UP TO 150 BAR

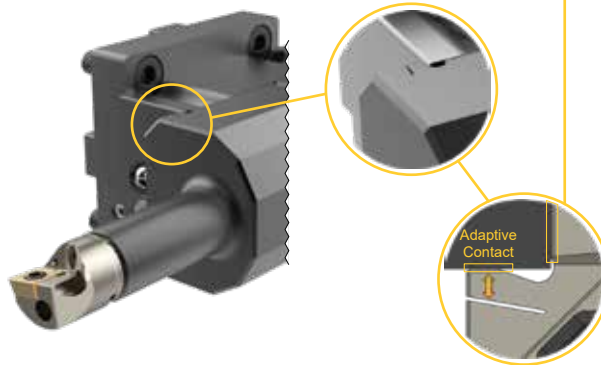

- **TAGLIO DI PRECARICO PER AUMENTARE LA RIGIDITÀ DEL SISTEMA DI BLOCCAGGIO E DURANTE LA LAVORAZIONE**  
PRELOAD CUTTING  
TO INCREASE THE RIGIDITY OF THE CLAMPING SYSTEM AND DURING MACHINING
- **MIGLIORAMENTO DELLA RIPETIBILITÀ DI POSIZIONAMENTO**  
MAXIMUM REPEATABILITY  
IN POSITIONING
- **MAGGIORE DURATA INSERTO**  
LONGER INSERT LIFE

Con una sola base è possibile svolgere più lavorazioni di tornitura interna, grazie alla possibilità di montare sulla medesima svariate tipologie di utensili.  
Several internal turning operations can be carried out with a single base, thanks to the possibility of mounting various types of tools on it.

**BASI / BASES**  
BMT - BIGLIA - DOOSAN - TAKISAWA  
NAKAMURA - CMZ - MAZAK

**BARENI / BORING BARS**  
Diam. 16 / 20 / 25 / 32  
3 x D - 4 x D

**BARENI / BORING BARS**  
Diam. 40 / 50  
3 x D - 4 x D

**PORTAPINZA-PORTABARENO**  
COLLET HOLDER - BORING BAR HOLDER  
E4-ER-16 / 20 / 25 / 32 / 40



**PINZE / COLLET**  
ER16 / 20 / 25 / 32 / 40



**BARENI ER25**  
ER25 BORING BARS  
Diam. 5 / 6 / 8 / 10 / 12 - 3 X D  
Diam. 8 / 10 / 12 - 5 X D



Sistema di Tornitura Interna Modulare / Internal Turning Modular System

Coupling modality

## AcquaStream

STANDARD SU TUTTE LE BASI,  
UTENSILI E PORTAUTENSILI  
"MODULSTAR SYSTEM"  
STANDARD ON ALL  
"MODULSTAR SYSTEM" BASES,  
TOOL AND TOOL HOLDER

MSS-ANS16/20/25/32  
Bareno standard  
Regular boring bar

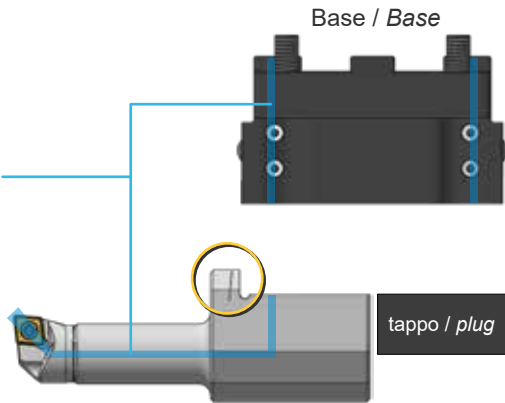

MSS-ANS16/20/25/32  
Bareno standard  
Regular boring bar

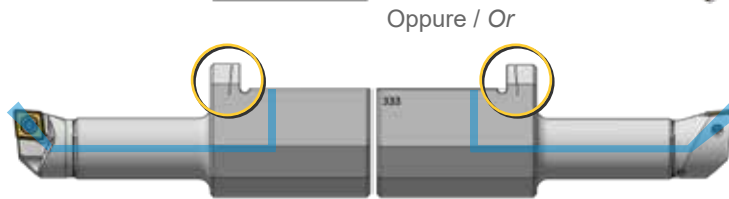

MSS-ANS16/20/25/32  
Bareno per contromandrino  
Counterspindle boring bar

MSS-ANS40/50  
Bareno standard  
Standard boring bar

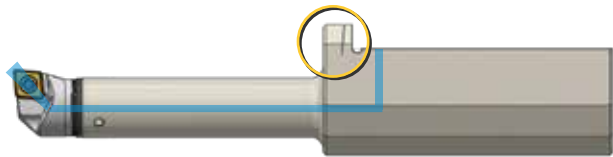

Oppure / Or

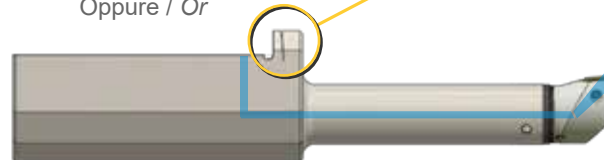

MSS-ANS40/50  
Bareno per contromandrino  
Counterspindle boring bar

**WALLCUT**<sup>®</sup>  
adaptive contact technology

STANDARD SU TUTTI GLI  
UTENSILI "PLANET SYSTEM"  
STANDARD ON ALL  
"PLANET SYSTEM" TOOLS

MSS-E4-ER16/20/25/32  
Portapinze ER / Portabareno ER  
ER Collet Holder / Boring Bar Holder

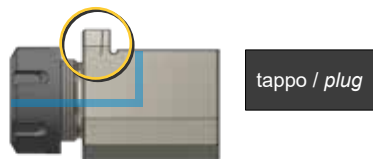

Oppure / Or



Pinza ER  
ER Collet



Bareno ER  
ER Boring Bar



Pinza ER contromandrino  
Counterspindle ER Collet

Oppure / Or



Bareno ER per contromandrino  
Counterspindle ER Boring Bar

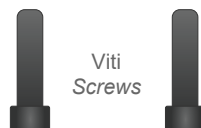



Basi per Sistema di Tornitura Interna Modulare / Base for Internal Turning Modular System

**BMT**



BMT45 / 55 / 65 / 75

**BMT (DMG-MORI)**



BMT40 / BMT60

**BIGLIA**



BG2 / BG3

**DOOSAN STATIC**



DS1 / DS2

**TAKISAWA TAIWAN**



TKT2

**NAKAMURA (CMZ)**



NKM55

**CMZ (DMG-MORI)**



CMZ30

**MAZAK**



MZK40 / MZK50

**PROMO**

**1**  
PZ / PCS

**BASI A SCELTA  
BASE OF YOUR CHOICE**

**PROMO**

**3**  
PZ / PCS

Ordine minimo  
Minimum order

Cod. PROMO	PREZZO / PRICE Singola Base / Single Base	<b>BMT</b>	Cod. PROMO	PREZZO / PRICE Singola Base / Single Base
PRM15-0001	€ 229,00	MSS-BMT45-045	PRM15-0016	€ 209,00
PRM15-0002	€ 239,00	MSS-BMT55-040	PRM15-0017	€ 219,00
PRM15-0003	€ 249,00	MSS-BMT65-052	PRM15-0018	€ 229,00
PRM15-0004	€ 279,00	MSS-BMT75-045	PRM15-0019	€ 259,00
Cod. PROMO	Singola base / Single base	<b>BMT (DMG-MORI)</b>	Cod. PROMO	Singola base / Single base
PRM15-0005	€ 249,00	MSS-BMT40-055	PRM15-0020	€ 229,00
PRM15-0006	€ 269,00	MSS-BMT60-060	PRM15-0021	€ 249,00
Cod. PROMO	Singola base / Single base	<b>BIGLIA</b>	Cod. PROMO	Singola base / Single base
PRM15-0007	€ 249,00	MSS-BG2-060	PRM15-0022	€ 229,00
PRM15-0008	€ 249,00	MSS-BG3-055	PRM15-0023	€ 229,00
Cod. PROMO	Singola base / Single base	<b>DOOSAN</b>	Cod. PROMO	Singola base / Single base
PRM15-0009	€ 249,00	MSS-DS1-035	PRM15-0024	€ 229,00
PRM15-0010	€ 249,00	MSS-DS2-040	PRM15-0025	€ 229,00
Cod. PROMO	Singola base / Single base	<b>TAKISAWA</b>	Cod. PROMO	Singola base / Single base
PRM15-0011	€ 249,00	MSS-TKT2-070	PRM15-0026	€ 229,00
Cod. PROMO	Singola base / Single base	<b>NAKAMURA (CMZ)</b>	Cod. PROMO	Singola base / Single base
PRM15-0012	€ 249,00	MSS-NKM55-035	PRM15-0027	€ 229,00
Cod. PROMO	Singola base / Single base	<b>CMZ (DMG-MORI)</b>	Cod. PROMO	Singola base / Single base
PRM15-0013	€ 249,00	MSS-CMZ30-035	PRM15-0028	€ 229,00
Cod. PROMO	Singola base / Single base	<b>MAZAK</b>	Cod. PROMO	Singola base / Single base
PRM15-0014	€ 359,00	MSS-MZK40-110	PRM15-0029	€ 339,00
PRM15-0015	€ 399,00	MSS-MZK50-170	PRM15-0030	€ 379,00

Bareni D16 per Sistema di Tornitura Interna Modulare / Boring Bar D16 for Internal Turning Modular System

Bareno / Boring Bar	D	Ratio	L*
MSS-ANS16-048	16	3 x D	48
MSS-ANS16-064	16	4 x D	64

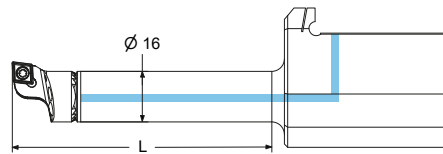

AcquaStream

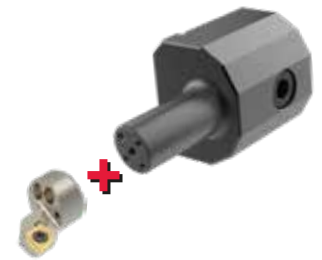

\* Lunghezza variabile in funzione della testina montata  
Length may vary depending on head mounted

### Composizione Set / Set Composition

Cod. PROMO	Bareno / Boring Bar	n° 1 Testina / Head	Prezzo / Price
<b>PRM15-0031</b>	MSS-ANS16-048	A vostra scelta / At your choice	<b>€ 139,00</b>
<b>PRM15-0032</b>	MSS-ANS16-064	vedi sotto / see below	<b>€ 149,00</b>

CS16	Testine disponibili / Available heads					Dim.
	CS16-SCLCR/L-06	CS16-SDUCR/L-07	CS16-STUCR/L-11	CS16-SDXCR/L-07	CS16-SIR/L-11	vedi / see p. 23

Bareni D20 per Sistema di Tornitura Interna Modulare / Boring Bar D20 for Internal Turning Modular System

Bareno / Boring Bar	D	Ratio	L*
MSS-ANS20-060	20	3 x D	60
MSS-ANS20-080	20	4 x D	80

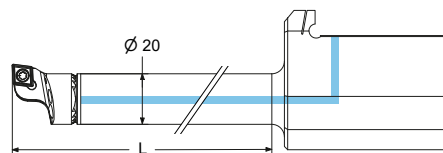

AcquaStream

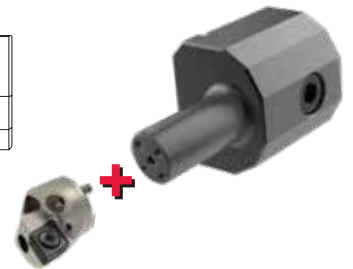

\* Lunghezza variabile in funzione della testina montata  
Length may vary depending on head mounted

### Composizione Set / Set Composition

Cod. PROMO	Bareno / Boring Bar	n° 1 Testina / Head	Prezzo / Price
<b>PRM15-0033</b>	MSS-ANS20-060	A vostra scelta / At your choice	<b>€ 169,00</b>
<b>PRM15-0034</b>	MSS-ANS20-080	vedi sotto / see below	<b>€ 179,00</b>

CS20	Testine disponibili / Available heads					Dim.
	CS20-SCLCR/L-09	CS20-SDNCR/L-11	CS20-SDQCR/L-07	CS20-SDQCR/L-11	CS20-STUCR/L-16	vedi / see p. 27
	CS20-SDUCR/L-07	CS20-SDUCR/L-11	CS20-STUCR/L-11			
	CS20-SDXCR/L-11	CS20-SVUCR/L-11	CS20-SIR/L-16			

Bareni D25 per Sistema di Tornitura Interna Modulare / Boring Bar D25 for Internal Turning Modular System

Bareno / Boring Bar	D	Ratio	L*
MSS-ANS25-075	25	3 x D	75
MSS-ANS25-100	25	4 x D	100

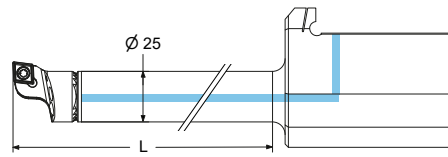

AcquaStream

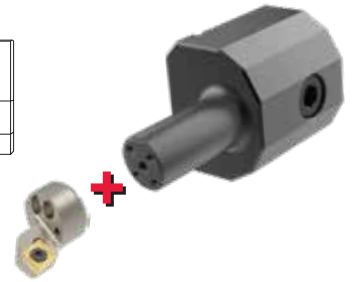

\* Lunghezza variabile in funzione della testina montata  
Length may vary depending on head mounted

### Composizione Set / Set Composition

Cod. PROMO	Bareno / Boring Bar	n° 1 Testina / Head	Prezzo / Price
<b>PRM15-0035</b>	MSS-ANS25-075	A vostra scelta / At your choice	<b>€ 199,00</b>
<b>PRM15-0036</b>	MSS-ANS25-100	vedi sotto / see below	<b>€ 219,00</b>

CS25	Testine disponibili / Available heads			Dim.
	CS25-PCLNR/L-09	CS25-PDUNR/L-11	CS25-SCLCR/L-09	vedi / see p. 28
	CS25-SDUCR/L-11	CS25-SDXCR/L-11	CS25-STUCR/L-16	
	CS25-SVUBR/L-16	CS25-SVUCR/L-16	CS25-SIR/L-16	

Bareni D32 per Sistema di Tornitura Interna Modulare / Boring Bar D32 for Internal Turning Modular System

Bareno / Boring Bar	D	Ratio	L*
MSS-ANS32-096	32	3 x D	96
MSS-ANS32-128	32	4 x D	128

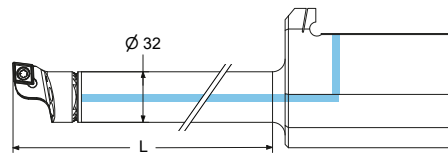

AcquaStream

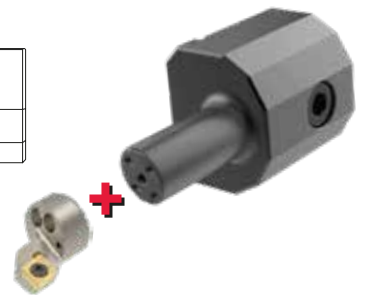

\* Lunghezza variabile in funzione della testina montata  
Length may vary depending on head mounted

### Composizione Set / Set Composition

Cod. PROMO	Bareno / Boring Bar	n° 1 Testina / Head	Prezzo / Price
<b>PRM15-0037</b>	MSS-ANS32-096	A vostra scelta / At your choice	<b>€ 219,00</b>
<b>PRM15-0038</b>	MSS-ANS32-128	vedi sotto / see below	<b>€ 239,00</b>

CS32	Testine disponibili / Available heads			Dim.
	CS32-PCLNR/L-12	CS32-PDUNR/L-11	CS32-SCLCR/L-09	vedi / see p. 29
	CS32-SDUCR/L-11	CS32-SDXCR/L-11	CS32-STUCR/L-16	
	CS32-SVUBR/L-16	CS32-SVUCR/L-16	CS32-SIR/L-16	

Bareni D40 per Sistema di Tornitura Interna Modulare / Boring Bar D40 for Internal Turning Modular System

Bareno / Boring Bar	D	Ratio	L*
MSS-ANS40-120	40	3 x D	120
MSS-ANS40-160	40	4 x D	160

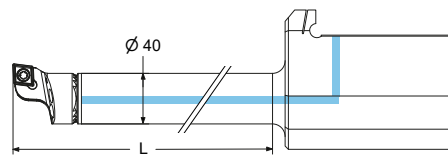

AcquaStream

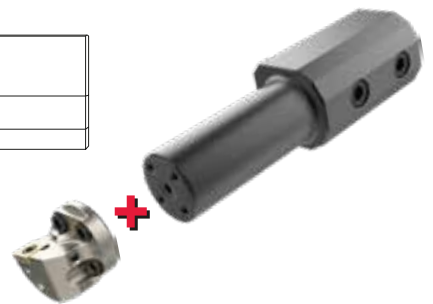

\* Lunghezza variabile in funzione della testina montata  
Length may vary depending on head mounted

### Composizione Set / Set Composition

Cod. PROMO	Bareno / Boring Bar	n° 1 Testina / Head	Prezzo / Price
<b>PRM15-0039</b>	MSS-ANS40-120	A vostra scelta / At your choice	<b>€ 279,00</b>
<b>PRM15-0040</b>	MSS-ANS40-160	vedi sotto / see below	<b>€ 299,00</b>

CS40	Testine disponibili / Available heads				Dim.
	CS40-DCLNR/L-12/16	CS40-DDQNR/L-15	CS40-DDUNR/L-15	CS40-DTUNR/L-16/22	vedi / see p. 31
	CS40-DVUNR/L-16	CS40-DWLNR/L-08	CS40-SCLCR/L-12	CS40-SDQCR/L-11	
	CS40-SDUCR/L-11/15	CS40-STUCR/L-16	CS40-SVUBR/L-16	CS40-SVUCR/L-16	
	CS40-DIR/L-16/22	CS40-PU10R/L	CS40-CIGR/L-20/30/40/50-11		

Bareni D50 per Sistema di Tornitura Interna Modulare / Boring Bar D50 for Internal Turning Modular System

Bareno / Boring Bar	D	Ratio	L*
MSS-ANS50-150	50	3 x D	150
MSS-ANS50-200	50	4 x D	200

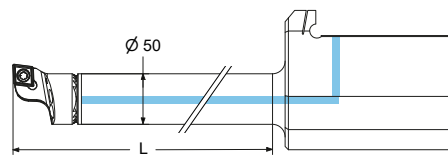

AcquaStream

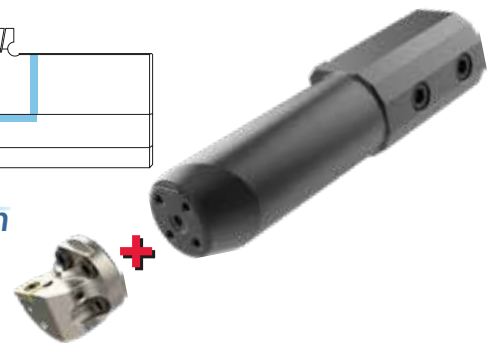

\* Lunghezza variabile in funzione della testina montata  
Length may vary depending on head mounted

### Composizione Set / Set Composition

Cod. PROMO	Bareno / Boring Bar	n° 1 Testina / Head	Prezzo / Price
<b>PRM15-0041</b>	MSS-ANS50-150	A vostra scelta / At your choice	<b>€ 359,00</b>
<b>PRM15-0042</b>	MSS-ANS50-200	vedi sotto / see below	<b>€ 379,00</b>

CS40	Testine disponibili / Available heads				Dim.
	CS40-DCLNR/L-12/16	CS40-DDQNR/L-15	CS40-DDUNR/L-15	CS40-DTUNR/L-16/22	vedi / see p. 31
	CS40-DVUNR/L-16	CS40-DWLNR/L-08	CS40-SCLCR/L-12	CS40-SDQCR/L-11	
	CS40-SDUCR/L-11/15	CS40-STUCR/L-16	CS40-SVUBR/L-16	CS40-SVUCR/L-16	
	CS40-DIR/L-16/22	CS40-PU10R/L	CS40-CIGR/L-20/30/40/50-11		



Portapinze ER per Sistema di Tornitura e Troncatura Modulare / ER Collet Holder for Turning and Parting-Off Modular System

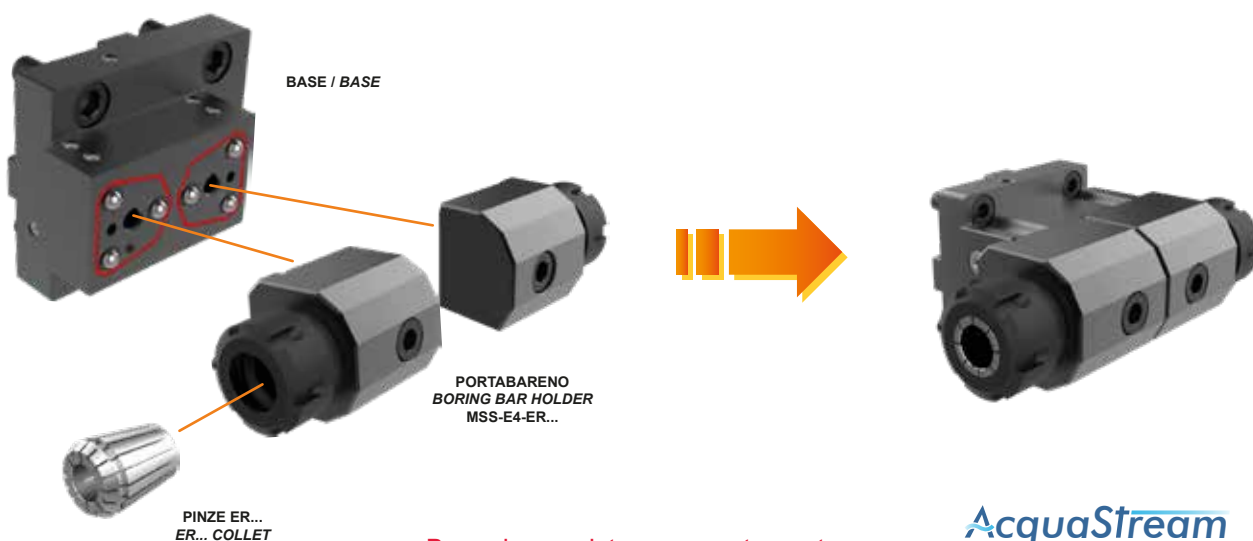

Base da acquistare separatamente  
Base to be purchased separately

Composizione / Composition				
Cod. PROMO	Portapinza / Collet Holder	Q.tà / Q. ty	Pinze da abbinare / Collet to match	Prezzo / Price
PRM15-0043	MSS-E4-ER16	3	ERC16	€ 110,00
PRM15-0044	MSS-E4-ER20	3	ERC20	€ 110,00
PRM15-0045	MSS-E4-ER25	3	ERC25	€ 110,00
PRM15-0046	MSS-E4-ER32	3	ERC32	€ 110,00
PRM15-0047	MSS-SET-E4-ER	4	ERC16-20-25-32	€ 400,00

## SET Portapinza + serie di Pinze ER

Set ER Collet Holder + ER Collet series

Composizione Set / Set Composition			
Cod. PROMO	n° 1 Portapinza / Collet Holder	n° 1 Serie di Pinze / Collet series	Prezzo / Price
PRM15-0048	MSS-E4-ER16	MSS-ERC16-10	€ 240,00
PRM15-0049	MSS-E4-ER20	MSS-ERC20-12	€ 250,00
PRM15-0050	MSS-E4-ER25	MSS-ERC25-15	€ 290,00
PRM15-0051	MSS-E4-ER32	MSS-ERC32-18	€ 330,00



Articolo / Item	Diametro / Diameter (D)	N° Pinze / Collet
MSS-ERC16-10	D 1-10 x 1 mm	10
MSS-ERC20-12	D 2-13 x 1 mm	12
MSS-ERC25-15	D 2-16 x 1 mm	15
MSS-ERC32-18	D 3-20 x 1 mm	18

**NEW**

# ModulSTAR System - Portabareni E25

Portabareni E25 per Sistema di Tornitura e Troncatura Modulare / E25 Boring Bars Holder for Turning and Parting-Off Modular System

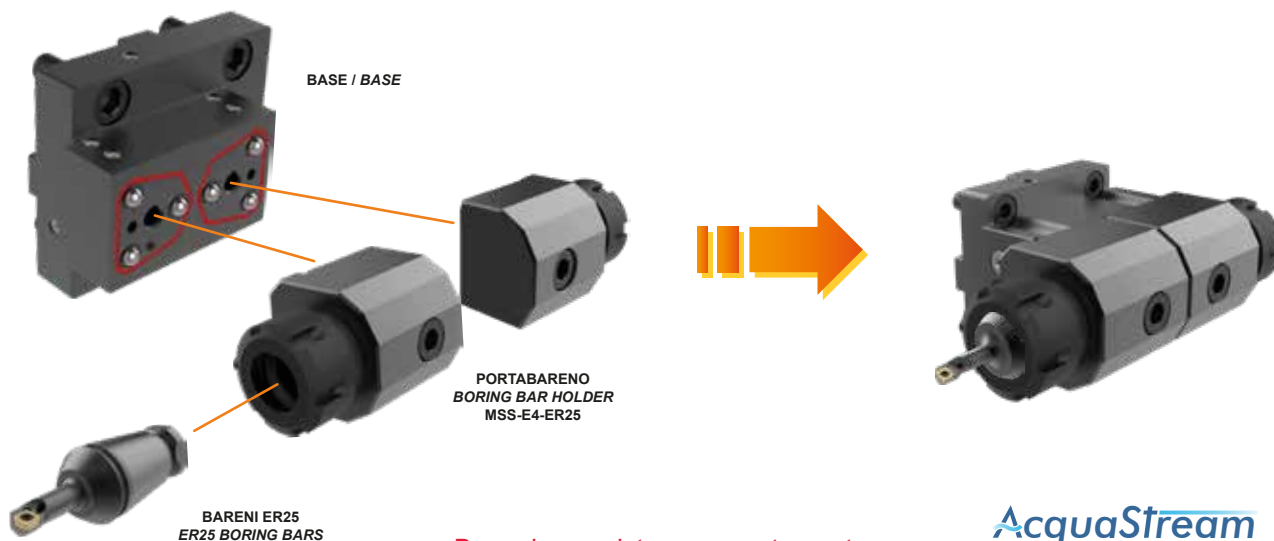

Base da acquistare separatamente  
Base to be purchased separately

### Composizione Set / Set Composition

Cod. PROMO	n° 1 Portabareno / Boring Bar Holder	n° 1 Bareno / Boring Bar a tua scelta / of your choice	Prezzo / Price
PRM15-0052		MSS-E25-A0503-...	€ 210,00
PRM15-0053		MSS-E25-A0603-...	€ 210,00
PRM15-0054		MSS-E25-A0803-...	€ 210,00
PRM15-0055		MSS-E25-A0805-...	€ 230,00
PRM15-0056		MSS-E25-A1003-...	€ 210,00
PRM15-0057		MSS-E25-A1005-...	€ 230,00
PRM15-0058		MSS-E25-A1203-...	€ 210,00
PRM15-0059		MSS-E25-A1205-...	€ 230,00

### Bareni E25 disponibili / E25 Boring Bars available

			
D 5 - 3xD	D 6 - 3xD	D 8 - 3xD	D 8 - 5xD
MSS-E25-A0503-SWUCL/R-02	MSS-E25-A0603-SWUCL/R-02	MSS-E25-A0803-SCLCL/R-06 MSS-E25-A0803-STUCL/R-06 MSS-E25-A0803-SWUCL/R-02	MSS-E25-A0805-SCLCL/R-06 MSS-E25-A0805-STUCL/R-06
			
D 10 - 3xD	D 10 - 5xD	D 12 - 3xD	D 12 - 5xD
MSS-E25-A1003-SCLCL/R-06 MSS-E25-A1003-SDQCL/R-07 MSS-E25-A1003-SDUCL/R-07 MSS-E25-A1003-STUCL/R-11 MSS-E25-A1003-SIL/R-11	MSS-E25-A1005-SCLCL/R-06 MSS-E25-A1005-SDQCL/R-07 MSS-E25-A1005-SDUCL/R-07 MSS-E25-A1005-STUCL/R-11 MSS-E25-A1005-SIL/R-11	MSS-E25-A1203-SCLCL/R-06 MSS-E25-A1203-SDQCL/R-07 MSS-E25-A1203-SDUCL/R-07 MSS-E25-A1203-STUCL/R-11 MSS-E25-A1203-SIL/R-11 MSS-E25-A1203-CIGL/R-20 MSS-E25-A1203-CIGL/R-30	MSS-E25-A1205-SCLCL/R-06 MSS-E25-A1205-SDQCL/R-07 MSS-E25-A1205-SDUCL/R-07 MSS-E25-A1205-STUCL/R-11 MSS-E25-A1205-SIL/R-11



Bareni E25 per Sistema di Tornitura e Troncatura Modulare / E25 Boring Bars for Turning and Parting-Off Modular System

**3**  
BARENI E25 / BORING BARS  
A SCELTA / OF YOUR CHOICE

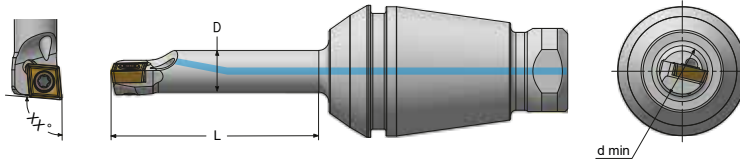

AcquaStream  
by COMAND TOOL

Cod. PROMO	Ordine Minimo / Minimum Order	Prezzo / Price singolo barenò / single boring bar
PRM15-0060	n° 3 bareni / boring bars 3xD	€ 99,00
PRM15-0061	n° 3 bareni / boring bars 5xD	€ 119,00

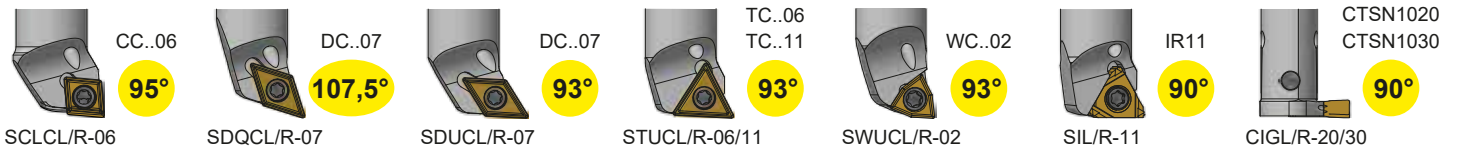

 SCLCL/R-06	 SDQCL/R-07	 SDUCL/R-07	 STUCL/R-06/11	 SWUCL/R-02	 SIL/R-11	 CIGL/R-20/30	
D 5 - 3xD L = 15 mm MSS-E25-A0503-SWUCL/R-02 d min = 6,5 mm	D 6 - 3xD L = 18 mm MSS-E25-A0603-SWUCL/R-02 d min = 8 mm	D 8 - 3xD L = 24 mm MSS-E25-A0803-SCLCL/R-06 d min = 10 mm MSS-E25-A0803-STUCL/R-06 d min = 11 mm MSS-E25-A0803-SWUCL/R-02 d min = 10 mm	D 8 - 5xD L = 40 mm MSS-E25-A0805-SCLCL/R-06 d min = 10 mm MSS-E25-A0805-STUCL/R-06 d min = 11 mm	D 10 - 3xD L = 30 mm MSS-E25-A1003-SCLCL/R-06 d min = 13 mm MSS-E25-A1003-SDQCL/R-07 d min = 13 mm MSS-E25-A1003-SDUCL/R-07 d min = 15 mm MSS-E25-A1003-STUCL/R-11 d min = 13 mm MSS-E25-A1003-SIL/R-11 d min = 13 mm	D 10 - 5xD L = 50 mm MSS-E25-A1005-SCLCL/R-06 d min = 13 mm MSS-E25-A1005-SDQCL/R-07 d min = 13 mm MSS-E25-A1005-SDUCL/R-07 d min = 15 mm MSS-E25-A1005-STUCL/R-11 d min = 13 mm MSS-E25-A1005-SIL/R-11 d min = 13 mm	D 12 - 3xD L = 36 mm MSS-E25-A1203-SCLCL/R-06 d min = 16 mm MSS-E25-A1203-SDQCL/R-07 d min = 16 mm MSS-E25-A1203-SDUCL/R-07 d min = 18 mm MSS-E25-A1203-STUCL/R-11 d min = 16 mm MSS-E25-A1203-SIL/R-11 d min = 15 mm MSS-E25-A1203-CIGL/R-20 d min = 16 mm MSS-E25-A1203-CIGL/R-30 d min = 16 mm	D 12 - 5xD L = 60 mm MSS-E25-A1205-SCLCL/R-06 d min = 16 mm MSS-E25-A1205-SDQCL/R-07 d min = 16 mm MSS-E25-A1205-SDUCL/R-07 d min = 18 mm MSS-E25-A1205-STUCL/R-11 d min = 16 mm MSS-E25-A1205-SIL/R-11 d min = 15 mm

Basi Radiali 0° per Sistema di Tornitura e Troncatura Modulare / Radial Base 0° for Turning and Parting-Off Modular System

## BMT



B1B4C-A



B2B3C-B

## BMT DOPPIO



D1D2C

## BMT (DMG-MORI)



B1B4C-A



B2B3C-B

## BIGLIA 2S



B1B4C-A



B2B3C-B

## BIGLIA 2L



B1B4C-A



B2B3C-B

## BIGLIA 3S



B1B4C-A



B2B3C-B

## BIGLIA 3L



B1B4C-A



B2B3C-B

**PROMO**

**3**  
PZ / PCS

Ordine minimo  
Minimum order

**BASI A SCELTA  
BASE OF YOUR CHOICE**

**PROMO**

**5**  
PZ / PCS

Ordine minimo  
Minimum order

Cod. PROMO	PREZZO / PRICE Singola Base / Single Base	BMT	Cod. PROMO	PREZZO / PRICE Singola Base / Single Base
PRM12-0001	€ 169,00	MTS-BMT45-B1B4C-A	PRM12-0023	€ 149,00
PRM12-0002	€ 179,00	MTS-BMT55-B1B4C-A	PRM12-0024	€ 159,00
PRM12-0003	€ 189,00	MTS-BMT65-B1B4C-A	PRM12-0025	€ 169,00
PRM12-0004	€ 209,00	MTS-BMT75-B1B4C-A	PRM12-0026	€ 189,00
PRM12-0005	€ 169,00	MTS-BMT45-B2B3C-B	PRM12-0027	€ 149,00
PRM12-0006	€ 179,00	MTS-BMT55-B2B3C-B	PRM12-0028	€ 159,00
PRM12-0007	€ 189,00	MTS-BMT65-B2B3C-B	PRM12-0029	€ 169,00
PRM12-0008	€ 209,00	MTS-BMT75-B2B3C-B	PRM12-0030	€ 189,00

Cod. PROMO	Singola base / Single base	BMT DOPPIO	Cod. PROMO	Singola base / Single base
PRM12-0110	€ 289,00	MTS-BMT65-D1D2C	PRM12-0127	€ 269,00

Cod. PROMO	Singola base / Single base	BMT (DMG-MORI)	Cod. PROMO	Singola base / Single base
PRM12-0135	€ 189,00	MTS-BMT40-B1B4C-A	PRM12-0143	€ 169,00
PRM12-0136	€ 209,00	MTS-BMT60-B1B4C-A	PRM12-0144	€ 189,00
PRM12-0137	€ 189,00	MTS-BMT40-B2B3C-B	PRM12-0145	€ 169,00
PRM12-0138	€ 209,00	MTS-BMT60-B2B3C-B	PRM12-0146	€ 189,00

Cod. PROMO	Singola base / Single base	BIGLIA	Cod. PROMO	Singola base / Single base
PRM12-0013	€ 179,00	MTS-BG2S-B1B4C-A	PRM12-0035	€ 159,00
PRM12-0014	€ 189,00	MTS-BG2S-B2B3C-B	PRM12-0036	€ 169,00
PRM12-0015	€ 179,00	MTS-BG2L-B1B4C-A	PRM12-0037	€ 159,00
PRM12-0016	€ 189,00	MTS-BG2L-B2B3C-B	PRM12-0038	€ 169,00
PRM12-0139	€ 169,00	MTS-BG3S-B1B4C-A	PRM12-0147	€ 149,00
PRM12-0140	€ 169,00	MTS-BG3S-B2B3C-B	PRM12-0148	€ 149,00
PRM12-0141	€ 169,00	MTS-BG3L-B1B4C-A	PRM12-0149	€ 149,00
PRM12-0142	€ 169,00	MTS-BG3L-B2B3C-B	PRM12-0150	€ 149,00



Basi Radiali 0° per Sistema di Tornitura e Troncatura Modulare / Radial Base 0° for Turning and Parting-Off Modular System



**PROMO**

**3**  
PZ / PCS

Ordine minimo  
Minimum order

**BASI A SCELTA  
BASE OF YOUR CHOICE**

**PROMO**

**5**  
PZ / PCS

Ordine minimo  
Minimum order

Cod. PROMO	PREZZO / PRICE Singola Base / Single Base	DOOSAN STATIC	Cod. PROMO	PREZZO / PRICE Singola Base / Single Base
PRM12-0009	€ 149,00	MTS-DS1L-B1B4C-A	PRM12-0031	€ 129,00
PRM12-0010	€ 149,00	MTS-DS1L-B2B3C-B	PRM12-0032	€ 129,00
PRM12-0011	€ 169,00	MTS-DS2L-B1B4C-A	PRM12-0033	€ 149,00
PRM12-0012	€ 169,00	MTS-DS2L-B2B3C-B	PRM12-0034	€ 149,00
Cod. PROMO	Singola base / Single base	NAKAMURA (CMZ)	Cod. PROMO	Singola base / Single base
PRM12-0098	€ 189,00	MTS-NKM55-B1B4C-A	PRM12-0115	€ 169,00
PRM12-0099	€ 189,00	MTS-NKM55-B2B3C-B	PRM12-0116	€ 169,00
Cod. PROMO	Singola base / Single base	NAKAMURA DOPPIO	Cod. PROMO	Singola base / Single base
PRM12-0198	€ 299,00	<b>NEW</b> MTS-NKM55-D1C	PRM12-0202	€ 279,00
Cod. PROMO	Singola base / Single base	CMZ 30 (DMG-MORI)	Cod. PROMO	Singola base / Single base
PRM12-0100	€ 189,00	MTS-CMZ30-B1B4C-A	PRM12-0117	€ 169,00
PRM12-0101	€ 189,00	MTS-CMZ30-B2B3C-B	PRM12-0118	€ 169,00
Cod. PROMO	Singola base / Single base	TAKISAWA TAIWAN	Cod. PROMO	Singola base / Single base
PRM12-0151	€ 189,00	MTS-TKT1M-B1B4C-A	PRM12-0155	€ 169,00
PRM12-0152	€ 189,00	MTS-TKT1M-B2B3C-B	PRM12-0156	€ 169,00
PRM12-0199	€ 189,00	<b>NEW</b> MTS-TKT2M-B1B4C-A	PRM12-0203	€ 169,00
PRM12-0200	€ 189,00	<b>NEW</b> MTS-TKT2M-B2B3C-B	PRM12-0204	€ 169,00
Cod. PROMO	Singola base / Single base	TAKISAWA DOPPIO	Cod. PROMO	Singola base / Single base
PRM12-0201	€ 299,00	<b>NEW</b> MTS-TKT2M-D1C	PRM12-0205	€ 279,00
Cod. PROMO	Singola base / Single base	POLYGONAL "C"	Cod. PROMO	Singola base / Single base
PRM12-0153	€ 269,00	MTS-C06-B1C-A	PRM12-0157	€ 249,00
PRM12-0154	€ 269,00	MTS-C06-B3C-B	PRM12-0158	€ 249,00

Basi Radiali 0° per Sistema di Tornitura e Troncatura Modulare / Radial Base 0° for Turning and Parting-Off Modular System

**NEW**

OKUMA

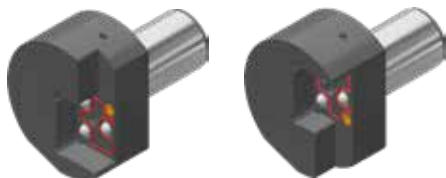

B1C-A

B3C-B

MAZAK



B1C-A

B3C-B

VDI 25W (INDEX)

VDI

VDI DOPPIO



B1B4C-A

B2B3C-B



B1C-A

B3C-B



D1C

D2C

**PROMO**

**3**  
PZ / PCS

Ordine minimo  
Minimum order

**BASI A SCELTA  
BASE OF YOUR CHOICE**

**PROMO**

**5**  
PZ / PCS

Ordine minimo  
Minimum order

Cod. PROMO	PREZZO / PRICE Singola Base / Single Base	OKUMA	Cod. PROMO	PREZZO / PRICE Singola Base / Single Base
PRM12-0206	€ 149,00	<b>NEW</b> MTS-OKM40-B1C-A	PRM12-0208	€ 139,00
PRM12-0207	€ 149,00	<b>NEW</b> MTS-OKM40-B3C-B	PRM12-0209	€ 139,00

Cod. PROMO	Singola base / Single base	MAZAK	Cod. PROMO	Singola base / Single base
PRM12-0094	€ 359,00	MTS-MZK40-B1C-A	PRM12-0111	€ 329,00
PRM12-0095	€ 389,00	MTS-MZK50-B1C-A	PRM12-0112	€ 359,00
PRM12-0096	€ 359,00	MTS-MZK40-B3C-B	PRM12-0113	€ 329,00
PRM12-0097	€ 389,00	MTS-MZK50-B3C-B	PRM12-0114	€ 359,00

Cod. PROMO	Singola base / Single base	VDI 25W (INDEX)	Cod. PROMO	Singola base / Single base
PRM12-0102	€ 179,00	MTS-VDI25W-B1B4C-A	PRM12-0119	€ 159,00
PRM12-0103	€ 179,00	MTS-VDI25W-B2B3C-B	PRM12-0120	€ 159,00

Cod. PROMO	Singola base / Single base	VDI	Cod. PROMO	Singola base / Single base
PRM12-0017	€ 159,00	MTS-VDI30-B1C-A	PRM12-0039	€ 139,00
PRM12-0018	€ 169,00	MTS-VDI40-B1C-A	PRM12-0040	€ 149,00
PRM12-0019	€ 189,00	MTS-VDI50-B1C-A	PRM12-0041	€ 179,00
PRM12-0020	€ 159,00	MTS-VDI30-B3C-B	PRM12-0042	€ 139,00
PRM12-0021	€ 169,00	MTS-VDI40-B3C-B	PRM12-0043	€ 149,00
PRM12-0022	€ 189,00	MTS-VDI50-B3C-B	PRM12-0044	€ 179,00

Cod. PROMO	Singola base / Single base	VDI DOPPIO	Cod. PROMO	Singola base / Single base
PRM12-0104	€ 249,00	MTS-VDI30-D1C	PRM12-0121	€ 229,00
PRM12-0105	€ 269,00	MTS-VDI40-D1C	PRM12-0122	€ 249,00
PRM12-0106	€ 279,00	MTS-VDI50-D1C	PRM12-0123	€ 259,00
PRM12-0107	€ 249,00	MTS-VDI30-D2C	PRM12-0124	€ 229,00
PRM12-0108	€ 269,00	MTS-VDI40-D2C	PRM12-0125	€ 249,00
PRM12-0109	€ 279,00	MTS-VDI50-D2C	PRM12-0126	€ 259,00

Basi e Cartucce Standard per Sistema di Tornitura Modulare / Base and Regular Cartridges for Modular Turning System

**Cartucce STANDARD**  
**REGULAR Cartridges**

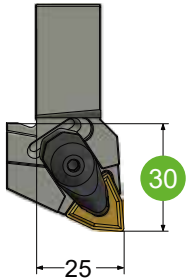

**AcquaStream**  
by COMAND TOOL



accoppiare sempre Basi e Cartucce aventi la stessa lettera finale nel codice (A / B)  
always match Base and Cartridges with the same end letter in the code (A / B)  
es: MTS-BMT45-B1B4C-A > MTS-DCLNL-12-A | MTS-BMT45-B2B3C-B > MTS-DCLNR-12-B

**Composizione Set / Set Composition**

Cod. PROMO	n° 1 Base / Base MTS a tua scelta / of your choice p. 11-12-13	n° 1 Cartuccia / Cartridge Standard / Regular	Prezzo / Price	
PRM12-0159	BMT45 / VDI30 / BG3S / BG3L	a tua scelta tra of your choice between  <b>D-System</b> <b>S-System</b> <b>Threading</b> <b>Seeger</b> <b>Grooving</b>	€ 269,00	
PRM12-0160	BMT40 / BMT55 / VDI40		€ 279,00	
PRM12-0161	<b>NEW</b> OKM40 / BMT60 / BMT65 / VDI50 / VDI25W		€ 299,00	
PRM12-0162	BG2S / BG2L / NKM55 / CMZ30 / TKT1M		€ 299,00	
PRM12-0163	<b>NEW</b> TKT2M / BMT75		€ 329,00	
PRM12-0164	DS1L / DS2L		€ 259,00	
PRM12-0165	MZK40		€ 459,00	
PRM12-0166	MZK50		€ 479,00	
PRM12-0167	VDI30 DOPPIO		vedi lista sotto see list below	€ 349,00
PRM12-0168	VDI40 DOPPIO / BMT65 DOPPIO		€ 369,00	
PRM12-0169	VDI50 DOPPIO	€ 379,00		

n°1 **Cartuccia Standard** a scelta da abbinare alla base / Regular cartridge to match the base

**Cartucce D-System Cartridges**

- MTS-DCLNL/R-12-A/B
- MTS-DCLNL/R-16-A/B
- MTS-DCLNL/R-19-A/B
- MTS-DCBNL/R-12-A/B
- MTS-DCKNL/R-12-A/B
- MTS-DDJNL/R-15-A/B
- MTS-DSSNL/R-12-A/B
- MTS-DSKNL/R-12-A/B
- MTS-DTJNL/R-16-A/B
- MTS-DVJNL/R-16-A/B
- MTS-DWLNL/R-06-A/B
- MTS-DWLNL/R-08-A/B

**Cartucce S-System Cartridges**

- MTS-SCLCL/R-09-A/B
- MTS-SCLCL/R-12-A/B
- MTS-SDJCL/R-11-A/B
- MTS-SDHCL/R-11-A/B
- MTS-SRDCL/R-08-A/B
- MTS-SRDCL/R-12-A/B
- MTS-SSSCL/R-12-A/B
- MTS-SVHBL/R-16-A/B
- MTS-SVHCL/R-16-A/B
- MTS-SVJBL/R-16-A/B
- MTS-SVJCL/R-16-A/B
- MTS-SVVBN-16-A/B
- MTS-SVVCN-16-A/B

**Cartucce Threading Cartridges**

- MTS-DEL/R-16-A/B
- MTS-DEL/R-22-A/B
- MTS-SEL/R-16-A/B
- MTS-SEL/R-22-A/B

**Cartucce Seeger Cartridges**

- MTS-CESL/R-16-A/B

**Cartucce Grooving Cartridges**

- CCGL/R 20 ...-A/B
- CCGL/R 30 ...-A/B
- CCGL/R 40 ...-A/B
- CCGL/R 50 ...-A/B
- CCGL/R 60 ...-A/B

**NEW MITSUBISHI p. 36**

- MCGL/R 30 ...-A/B
- MCGL/R 40 ...-A/B

**NEW ISCAR p. 37**

- ICGL/R 30 ...-A/B
- ICGL/R 40 ...-A/B
- ICGL/R 50 ...-A/B

**NEW KENAMETAL p. 38**

- KCGL/R 30 ...-A/B
- KCGL/R 40 ...-A/B
- KCGL/R 50 ...-A/B

Compatibili con inserto / Compatible with insert:  
MITSUBISHI - ISCAR - KENAMETAL



Basi e Cartucce Medie per Sistema di Tornitura Modulare / Base and Medium Cartridges for Modular Turning System

**Cartucce MEDIE ideali per Basi Doppie / MEDIUM Cartridges ideal for Double Base**



**!** accoppiare sempre Basi e Cartucce aventi la stessa lettera finale nel codice (A / B) ad eccezione delle Basi Doppie (MTS-...-D1D2C)  
always match Base and Cartridges with the same end letter in the code (A / B) except Double Bases (MTS-...-D1D2C)  
es: MTS-BMT45-B1B4C-A > MTS-DCLNL-12-AM | MTS-BMT45-B2B3C-B > MTS-DCLNR-12-BM

Composizione Set / Set Composition

Cod. PROMO	n° 1 Base DOPPIA / DOUBLE Base MTS a tua scelta / of your choice p. 11-12-13	n° 1 Cartuccia / Cartridge Medie / Medium	Prezzo / Price
PRM12-0178	VDI30 DOPPIO	a tua scelta tra of your choice between  D-System S-System Threading  vedi lista sotto see list below	€ 359,00
PRM12-0179	VDI40 DOPPIO / BMT65 DOPPIO		€ 379,00
PRM12-0210	<b>NEW</b> TKT2M DOPPIO <b>NEW</b> NKM55 DOPPIO		€ 389,00
PRM12-0180	VDI50 DOPPIO		€ 389,00

n°1 **Cartuccia Media** a scelta da abbinare alla base / Medium cartridge to match the base

**Cartucce D-System Cartridges**

MTS-DCLNL/R-12-AM/BM  
MTS-DDJNL/R-15-AM/BM

**Cartucce S-System Cartridges**

MTS-SDJCL/R-11-AM/BM  
MTS-SVJCL/R-16-AM/BM

**Cartucce Threading Cartridges**

MTS-SEL/R-16-AM/BM



MTS-DCLNL/R-12-AM/BM



MTS-DDJNL/R-15-AM/BM



MTS-SDJCL/R-11-AM/BM



MTS-SVJCL/R-16-AM/BM



MTS-SEL/R-16-AM/BM



Basi e Cartucce Lunghe per Sistema di Tornitura Modulare / Base and Long Cartridges for Modular Turning System

**Cartucce LUNGHE ideali per Contropunta / LONG Cartridges ideal for Tailstock**



**AcquaStream**  
by COMAND TOOL

**!** accoppiare sempre Basi e Cartucce aventi la stessa lettera finale nel codice (A / B)  
always match Base and Cartridges with the same end letter in the code (A / B)  
es: MTS-BMT45-B1B4C-A > MTS-DCLNL-12-AL | MTS-BMT45-B2B3C-B > MTS-DCLNR-12-BL

**Composizione Set / Set Composition**

Cod. PROMO	n° 1 Base / Base MTS a tua scelta / of your choice p. 11-12-13	n° 1 Cartuccia / Cartridge <b>Lunghe / Long</b>	Prezzo / Price
PRM12-0181	BMT45 / VDI30 / BG3S / BG3L	a tua scelta tra of your choice between  <b>D-System</b> <b>S-System</b> <b>Threading</b>  vedi lista sotto see list below	€ 289,00
PRM12-0182	BMT40 / MBT55 / VDI40		€ 299,00
PRM12-0183	<b>NEW</b> OKM40 / BMT60 / BMT65 / VDI50 / VDI25W		€ 319,00
PRM12-0184	BG2S / BG2L / NKM55 / CMZ30 / TKT1M		€ 319,00
PRM12-0185	<b>NEW</b> TKT2M / BMT75		€ 349,00
PRM12-0186	DS1L / DS2L		€ 279,00
PRM12-0187	MZK40		€ 479,00
PRM12-0188	MZK50		€ 499,00

n°1 **Cartuccia Lunga** a scelta da abbinare alla base / Long cartridge to match the base

**Cartucce D-System Cartridges**

- MTS-DCLNL/R-12-AL/BL
- MTS-DDJNL/R-15-AL/BL
- MTS-DWLNL/R-08-AL/BL

**Cartucce S-System Cartridges**

- MTS-SDJCL/R-11-AL/BL
- MTS-SVJBL/R-16-AL/BL
- MTS-SVJCL/R-16-AL/BL

**Cartucce Threading Cartridges**

- MTS-DEL/R-16-AL/BL



MTS-DCLNL/R-12-AL/BL



MTS-DDJNL/R-15-AL/BL



MTS-DWLNL/R-08-AL/BL



MTS-SDJCL/R-11-AL/BL



MTS-SVJBL/R-16-AL/BL



MTS-SVJCL/R-16-AL/BL



MTS-DEL/R-16-AL/BL

Cartucce Standard per Sistema di Tornitura Modulare / Regular Cartridges for Modular Turning System

**Cartucce Standard**  
Regular Cartridges

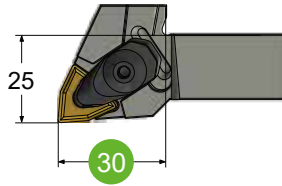

**AcquaStream**  
by COMAND TOOL

**PROMO 3** Prezzo / Price      Tipo Cartucce / Cartridges Type      **PROMO 5** Prezzo / Price

<b>Cod. PROMO</b> <b>PRM12-0085</b>	singola cartuccia / single cartridge <b>€ 129,00</b>	<b>FASTURN</b> D-System / S-System / Threading / Seeger	<b>Cod. PROMO</b> <b>PRM12-0086</b>	singola cartuccia / single cartridge <b>€ 119,00</b>
<b>Cod. PROMO</b> <b>PRM12-0194</b>	singola cartuccia / single cartridge <b>€ 89,00</b>	<b>FASTCUT</b> Grooving (CCG... / MCG... / ICG... / KCG...)	<b>Cod. PROMO</b> <b>PRM12-0195</b>	singola cartuccia / single cartridge <b>€ 79,00</b>

### Cartucce D-System Cartridges



### Cartucce S-System Cartridges



### Cartucce Threading Cartridges



### Cartucce Seeger Cartridges



### Cartucce Grooving Cartridges



Cartucce Medie per Sistema di Tornitura Modulare / Medium Cartridges for Turning Modular System

**Cartucce Medie**  
Medium Cartridges

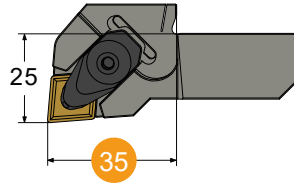

**AcquaStream**  
by COMAND TOOL

**3 / 5**  
CARTUCCE A SCELTA  
OF YOUR CHOICE

Cod. PROMO	Ordine Minimo / Minimum Order	Prezzo / Price singola cartuccia / single cartridge
<b>PRM12-0192</b>	<b>3 cartucce / cartridges</b>	<b>€ 139,00</b>
<b>PRM12-0193</b>	<b>5 cartucce / cartridges</b>	<b>€ 129,00</b>

Cartucce **D-System** Cartridges



CN..12

MTS-DCLNL/R-12-AM/BM  
MTS-DDJNL/R-15-AM/BM



DN..15

Cartucce **S-System** Cartridges



DC..11

MTS-SDJCL/R-11-AM/BM  
MTS-SVJCL/R-16-AM/BM



VC..16

Cartucce **Threading** Cartridges



IR..16 / ER..16

MTS-SEL/R-16-AM/BM

Cartucce Lunghe per Sistema di Tornitura Modulare / Long Cartridges for Turning Modular System

**Cartucce Lunghe**  
Long Cartridges

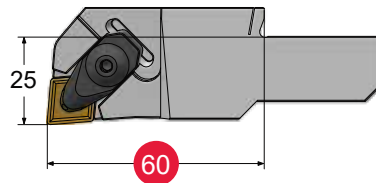

**AcquaStream**  
by COMAND TOOL

**3 / 5**  
CARTUCCE A SCELTA  
OF YOUR CHOICE

Cod. PROMO	Ordine Minimo / Minimum Order	Prezzo / Price singola cartuccia / single cartridge
<b>PRM12-0132</b>	<b>3 cartucce / cartridges</b>	<b>€ 149,00</b>
<b>PRM12-0133</b>	<b>5 cartucce / cartridges</b>	<b>€ 139,00</b>

Cartucce **D-System** Cartridges



CN..12

MTS-DCLNL/R-12-AL/BL  
MTS-DDJNL/R-15-AL/BL  
MTS-DWLNL/R-08-AL/BL



DN..15



WN..08

Cartucce **S-System** Cartridges



DC..11

MTS-SDJCL/R-11-AL/BL  
MTS-SVJBL/R-16-AL/BL  
MTS-SVJCL/R-16-AL/BL



VB..16



VC..16

Cartucce **Threading** Cartridges



IR..16 / ER..16

MTS-DEL/R-16-AL/BL

# MiniDABtool D10 - 6xD

**BARRA + 10 INSERTI**  
**BAR + 10 INSERTS**

MiniBarre D10 con dispositivo Antivibrante / MiniBars D10 with Antivibration device

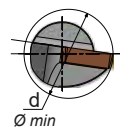
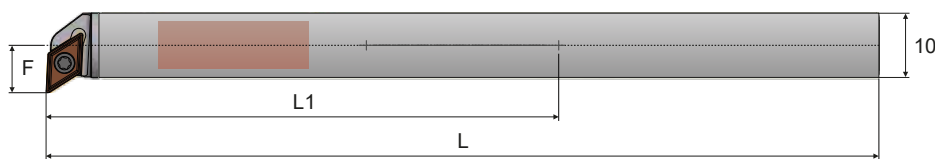

Inserti disponibili / Available inserts



95°

SCLCR/L06



93°

SDUCR/L07



93°

STUCR/L09

damper

**Compra 1 MiniDABtool**  
**Buy 1 MiniDABtool**  
**10 INSERTI GRATIS**  
**FREE INSERTS**

**NEW**

**PT8430**

ricopertura inserto  
insert coating

Composizione Set / Set Composition

Cod. PROMO	Barra / Bar	n° 10 Inserti / Inserts	L	L1	F	d min	Prezzo / Price
PRM13-0001	SFS10-06-SCLCR06	CCMT060204CSM PT8430	110	60	5,5	12	€ 209,00
PRM13-0002	SFS10-06-SDUCR07	DCMT070204CSM PT8430			8	14	€ 209,00
PRM13-0003	SFS10-06-STUCR09	TCMT090204CSF PT8430			6	12	€ 209,00
PRM13-0004	SFS10-06-SCLCL06	CCMT060204CSM PT8430			5,5	12	€ 209,00
PRM13-0005	SFS10-06-SDUCL07	DCMT070204CSM PT8430			8	14	€ 209,00
PRM13-0006	SFS10-06-STUCL09	TCMT090204CSF PT8430			6	12	€ 209,00

# MiniDABtool D10 - 8xD

MiniBarre D10 con dispositivo Antivibrante + Metallo Duro / MiniBars D10 with Antivibration device + Carbide

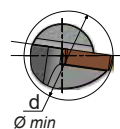
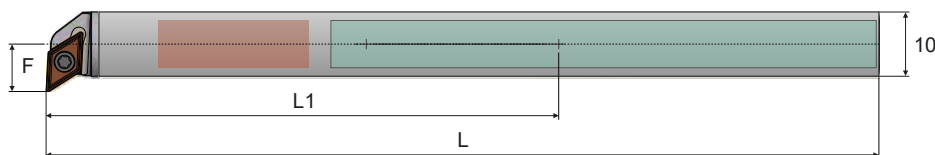

Inserti disponibili / Available inserts



95°

SCLCR/L06



93°

SDUCR/L07



93°

STUCR/L09

damper metallo duro / hard metal

**Compra 1 MiniDABtool**  
**Buy 1 MiniDABtool**  
**10 INSERTI GRATIS**  
**FREE INSERTS**

**NEW**

**PT8430**

ricopertura inserto  
insert coating

Composizione Set / Set Composition

Cod. PROMO	Barra / Bar	n° 10 Inserti / Inserts	L	L1	F	d min	Prezzo / Price
PRM13-0075	SFH10-08-SCLCR06	CCMT060204CSM PT8430	130	80	5,5	12	€ 349,00
PRM13-0076	SFH10-08-SDUCR07	DCMT070204CSM PT8430			8	14	€ 349,00
PRM13-0077	SFH10-08-STUCR09	TCMT090204CSF PT8430			6	12	€ 349,00
PRM13-0078	SFH10-08-SCLCL06	CCMT060204CSM PT8430			5,5	12	€ 349,00
PRM13-0079	SFH10-08-SDUCL07	DCMT070204CSM PT8430			8	14	€ 349,00
PRM13-0080	SFH10-08-STUCL09	TCMT090204CSF PT8430			6	12	€ 349,00



# MiniDABtool D10 - 10xD

**BARRA + 10 INSERTI**  
**BAR + 10 INSERTS**

MiniBarre D10 con dispositivo Antivibrante + Metallo Duro / MiniBars D10 with Antivibration device + Carbide

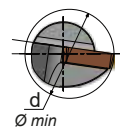
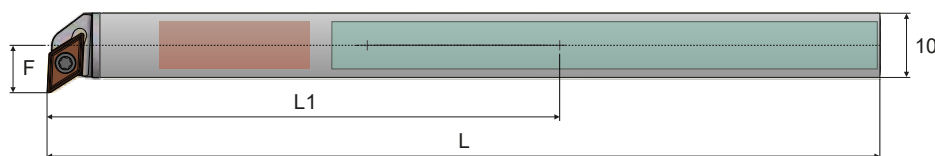

Inserti disponibili / Available inserts



95°



93°



93°

SCLCR/L06

SDUCR/L07

STUCR/L09



damper

metallo duro / hard metal

**Compra 1 MiniDABtool**  
**Buy 1 MiniDABtool**  
**10 INSERTI GRATIS**  
**FREE INSERTS**

**NEW**

**PT8430**

ricopertura inserto  
insert coating

Composizione Set / Set Composition

Cod. PROMO	Barra / Bar	n° 10 Inserti / Inserts	L	L1	F	d min	Prezzo / Price
PRM13-0007	SFH10-10-SCLCR06	CCMT060204CSM PT8430	150	100	5,5	12	€ 389,00
PRM13-0008	SFH10-10-SDUCR07	DCMT070204CSM PT8430			8	14	€ 389,00
PRM13-0009	SFH10-10-STUCR09	TCMT090204CSF PT8430			6	12	€ 389,00
PRM13-0010	SFH10-10-SCLCL06	CCMT060204CSM PT8430			5,5	12	€ 389,00
PRM13-0011	SFH10-10-SDUCL07	DCMT070204CSM PT8430			8	14	€ 389,00
PRM13-0012	SFH10-10-STUCL09	TCMT090204CSF PT8430			6	12	€ 389,00



Ottenete la massima efficienza dalle **MiniDABtool** utilizzando con il **portabareno ModuTURN System**

vai a / go to pag.25

**WALLCUT**  
adaptive contact technology

taglio di precarico per aumentare la rigidità del sistema di bloccaggio

1

Uscita Esterna EXT Liquido Refrigerante

2

Foro d'uscita Interna INT Liquido Refrigerante non presente su **MiniDABtool** D10 - D12

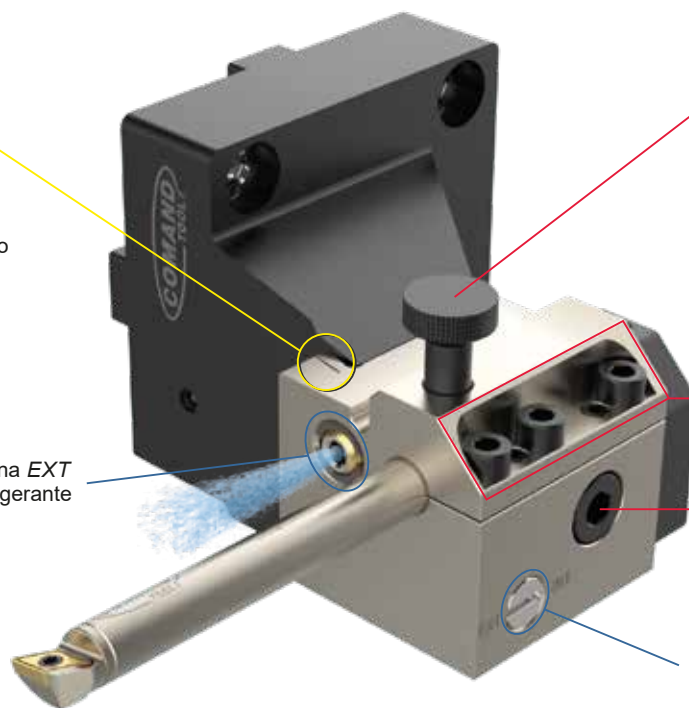

Vite di allineamento

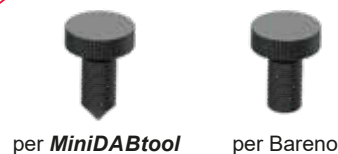

per **MiniDABtool**

per Bareno

Viti bloccaggio Bareno

Vite fissaggio Base - Portabareno

Deviatore Liquido Refrigerante Esterno EXT 1 | Interno INT 2

**AcquaStream**  
by COMAND TOOL

# MiniDABtool D12 - 6xD

**BARRA + 10 INSERTI**  
**BAR + 10 INSERTS**

MiniBarre D12 con dispositivo Antivibrante / MiniBars D12 with Antivibration device

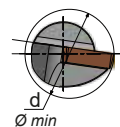
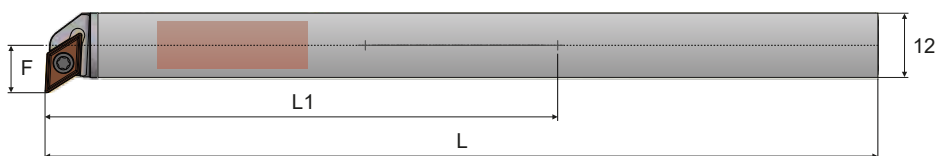

Inserti disponibili / Available inserts



**Compra 1 MiniDABtool**  
**Buy 1 MiniDABtool**  
**10 INSERTI GRATIS**  
**FREE INSERTS**

**NEW**  
**PT8430**  
ricopertura inserto  
insert coating

damper

Composizione Set / Set Composition

Cod. PROMO	Barra / Bar	n° 10 Inserti / Inserts	L	L1	F	d min	Prezzo / Price
PRM13-0013	SFS12-06-SCLCR06	CCMT060204CSM PT8430	132	72	6,5	14	€ 229,00
PRM13-0014	SFS12-06-SDUCR07	DCMT070204CSM PT8430			9	16	€ 229,00
PRM13-0015	SFS12-06-STUCR09	TCMT090204CSF PT8430			8	15	€ 229,00
PRM13-0016	SFS12-06-SCLCL06	CCMT060204CSM PT8430			6,5	14	€ 229,00
PRM13-0017	SFS12-06-SDUCL07	DCMT070204CSM PT8430			9	16	€ 229,00
PRM13-0018	SFS12-06-STUCL09	TCMT090204CSF PT8430			8	15	€ 229,00

# MiniDABtool D12 - 8xD

MiniBarre D12 con dispositivo Antivibrante + Metallo Duro / MiniBars D12 with Antivibration device + Carbide

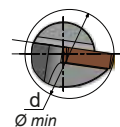
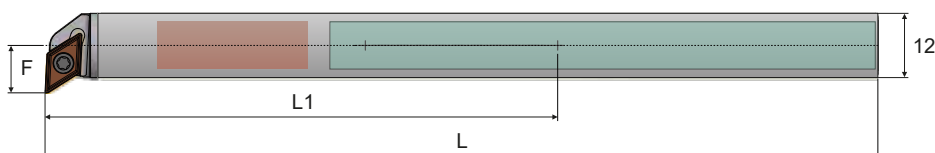

Inserti disponibili / Available inserts



**Compra 1 MiniDABtool**  
**Buy 1 MiniDABtool**  
**10 INSERTI GRATIS**  
**FREE INSERTS**

**NEW**  
**PT8430**  
ricopertura inserto  
insert coating

damper metallo duro / hard metal

Composizione Set / Set Composition

Cod. PROMO	Barra / Bar	n° 10 Inserti / Inserts	L	L1	F	d min	Prezzo / Price
PRM13-0081	SFH12-08-SCLCR06	CCMT060204CSM PT8430	156	96	6,5	14	€ 389,00
PRM13-0082	SFH12-08-SDUCR07	DCMT070204CSM PT8430			9	16	€ 389,00
PRM13-0083	SFH12-08-STUCR09	TCMT090204CSF PT8430			8	15	€ 389,00
PRM13-0084	SFH12-08-SCLCL06	CCMT060204CSM PT8430			6,5	14	€ 389,00
PRM13-0085	SFH12-08-SDUCL07	DCMT070204CSM PT8430			9	16	€ 389,00
PRM13-0086	SFH12-08-STUCL09	TCMT090204CSF PT8430			8	15	€ 389,00

# MiniDABtool D12 - 10xD

**BARRA + 10 INSERTI**  
**BAR + 10 INSERTS**

MiniBarre D12 con dispositivo Antivibrante / MiniBars D12 with Antivibration device

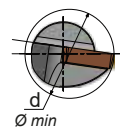
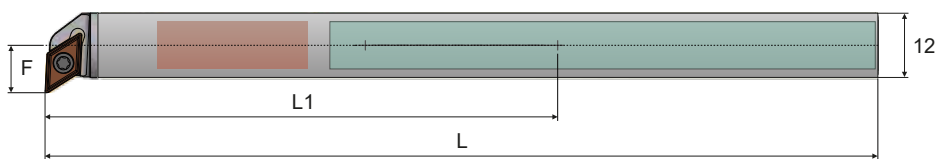

Inserti disponibili / Available inserts



**Compra 1 MiniDABtool**  
**Buy 1 MiniDABtool**  
**10 INSERTI GRATIS**  
**FREE INSERTS**

**NEW**  
**PT8430**  
ricopertura inserto  
insert coating

## Composizione Set / Set Composition

Cod. PROMO	Barra / Bar	n° 10 Inserti / Inserts	L	L1	F	d min	Prezzo / Price
PRM13-0019	SFH12-10-SCLCR06	CCMT060204CSM PT8430	180	120	6,5	14	€ 419,00
PRM13-0020	SFH12-10-SDUCR07	DCMT070204CSM PT8430			9	16	€ 419,00
PRM13-0021	SFH12-10-STUCR09	TCMT090204CSF PT8430			8	15	€ 419,00
PRM13-0022	SFH12-10-SCLCL06	CCMT060204CSM PT8430			6,5	14	€ 419,00
PRM13-0023	SFH12-10-SDUCL07	DCMT070204CSM PT8430			9	16	€ 419,00
PRM13-0024	SFH12-10-STUCL09	TCMT090204CSF PT8430			8	15	€ 419,00



Ottenete la massima efficienza dalle **MiniDABtool** utilizzando con il **portabareno ModuTURN System**

vai a / go to pag.25

**WALLCUT**  
adaptive contact technology

taglio di precarico per aumentare la rigidità del sistema di bloccaggio

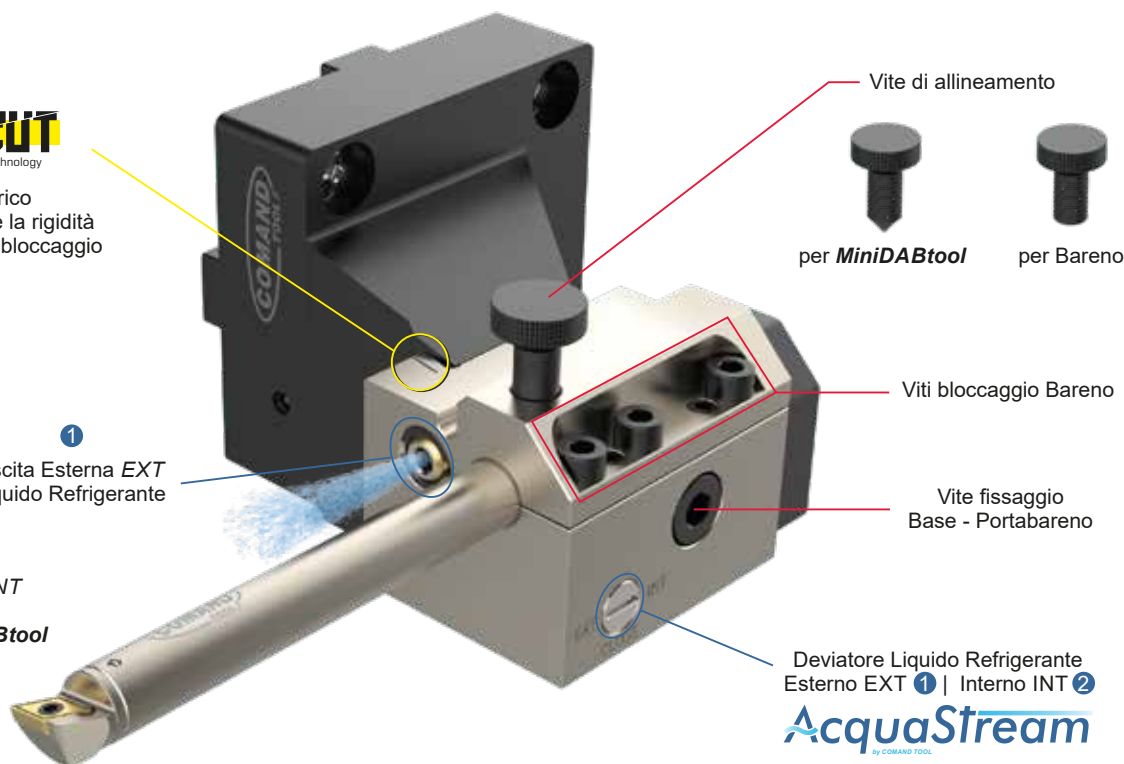

**AcquaStream**  
by COMAND TOOL

# MiniDABtool D16 - 6xD

**BARRA + TESTINA**  
**BAR + HEAD**

MiniBarre D16 con dispositivo Antivibrante / MiniBars D16 with Antivibration device

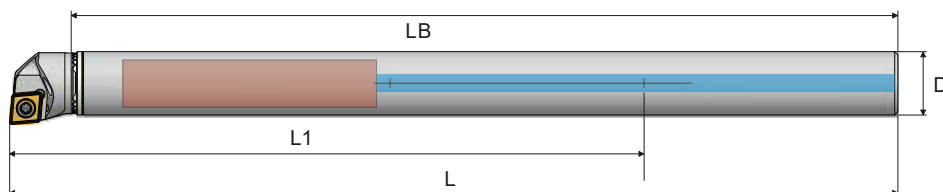

damper **AcquaStream**

Barra / Bar	D	L*	L1	LB
AFS16-06-140	16	160	96	140

\* Lunghezza variabile in funzione della testina montata / Length may vary depending on head mounted

### Composizione Set / Set Composition

Cod. PROMO	Barra / Bar	n° 1 Testina / Head	Prezzo / Price
<b>PRM13-0175</b>	AFS16-06-140	A vostra scelta / At your choice	<b>€ 519,00</b>

95°				93°				93°				93°				NEW 90°			
CS16-SCLCR/L-06				CS16-SDUCR/L-07				CS16-STUCR/L-11				CS16-SDXCR/L-07				CS16-SIR/L-11			
LT	F	d min		LT	F	d min		LT	F	d min		LT	F	d min		LT	F	d min	
20	11	20		20	11	20		20	11	20		26,6	13	22		20	11	20	

# MiniDABtool D16 - 8xD

MiniBarre D16 con dispositivo Antivibrante + Metallo Duro / MiniBars D16 with Antivibration device + Carbide

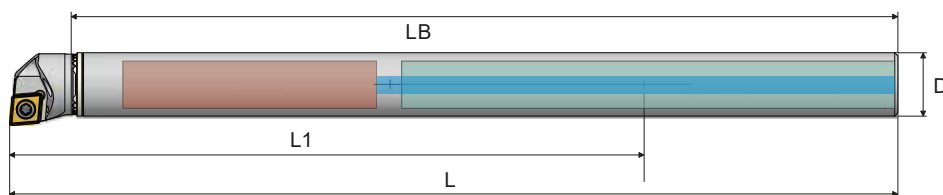

damper metallo duro / hard metal **AcquaStream**

Barra / Bar	D	L*	L1	LB
AFH16-08-172	16	192	128	172

\* Lunghezza variabile in funzione della testina montata / Length may vary depending on head mounted

### Composizione Set / Set Composition

Cod. PROMO	Barra / Bar	n° 1 Testina / Head	Prezzo / Price
<b>PRM13-0176</b>	AFH16-08-172	A vostra scelta / At your choice	<b>€ 769,00</b>

95°				93°				93°				NEW 90°							
CS16-SCLCR/L-06				CS16-SDUCR/L-07				CS16-STUCR/L-11				CS16-SDXCR/L-07				CS16-SIR/L-11			
LT	F	d min		LT	F	d min		LT	F	d min		LT	F	d min		LT	F	d min	
20	11	20		20	11	20		20	11	20		26,6	13	22		20	11	20	

# MiniDABtool D16 - 10xD

**BARRA + TESTINA**  
**BAR + HEAD**

MiniBarre D16 con dispositivo Antivibrante / MiniBars D16 with Antivibration device

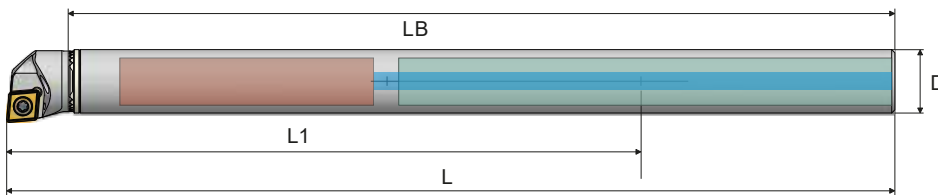

 damper metallo duro / hard metal **AcquaStream**

Barra / Bar	D	L*	L1	LB
AFH16-10-204	16	224	160	204

\* Lunghezza variabile in funzione della testina montata / Length may vary depending on head mounted

**BARRA + TESTINA**  
**BAR + HEAD**

Composizione Set / Set Composition			
Cod. PROMO	Barra / Bar	n° 1 Testina / Head	Prezzo / Price
<b>PRM13-0177</b>	AFH16-10-204	A vostra scelta / At your choice	<b>€ 959,00</b>

CS16-SCLCR/L-06				CS16-SDUCR/L-07				CS16-STUCR/L-11				CS16-SDXCR/L-07				CS16-SIR/L-11			
LT	F	d min		LT	F	d min		LT	F	d min		LT	F	d min		LT	F	d min	
20	11	20	95°	20	11	20	93°	20	11	20	93°	26,6	13	22	93°	20	11	20	90°

 Ottenete la massima efficienza dalle **MiniDABtool** utilizzando con il **portabareno ModuTURN System** vai a / go to pag.25

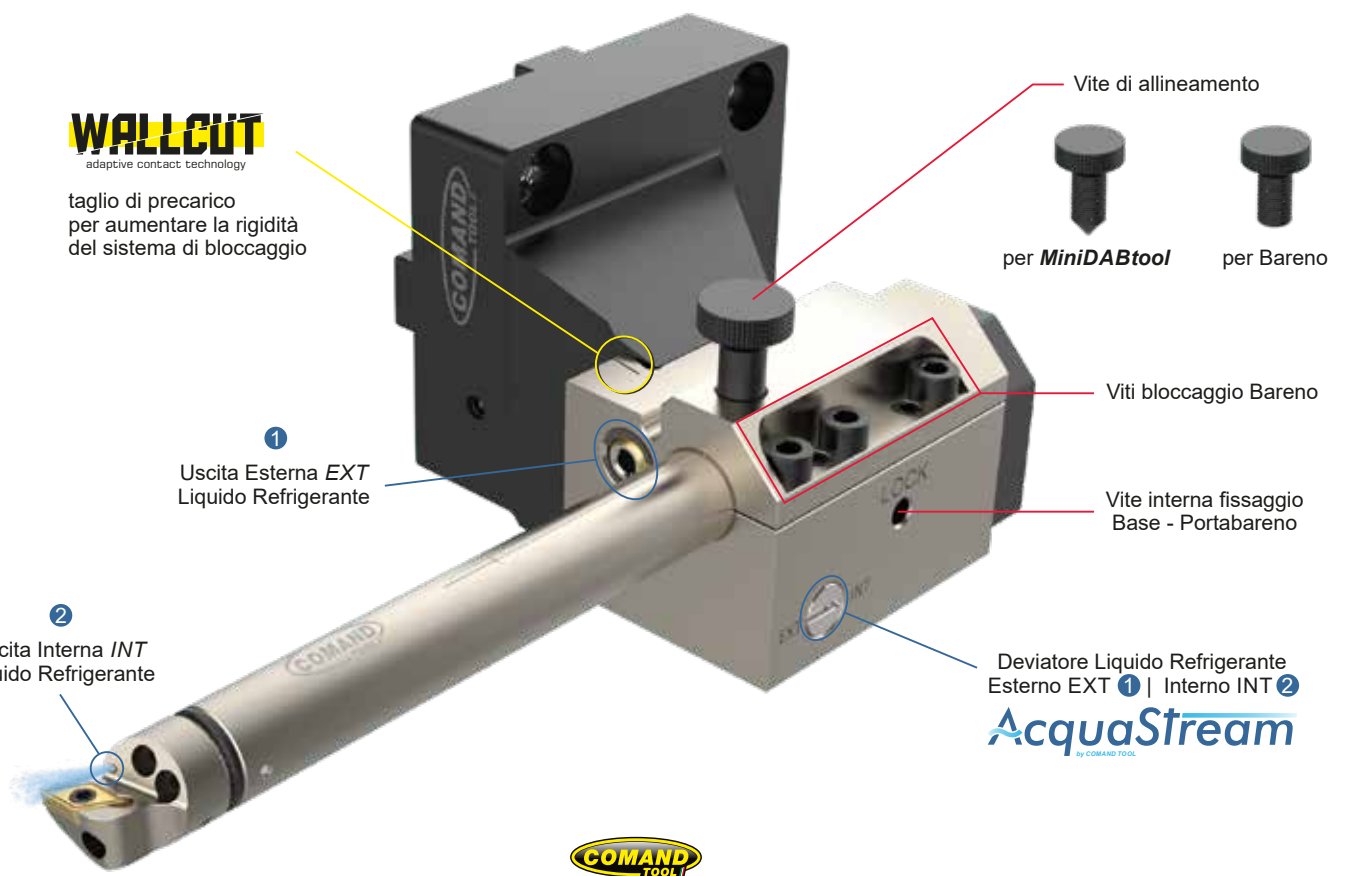

**AcquaStream**  
by COMAND TOOL



Tool holder for Modular Turning System

**BASE ASSIALE 90°  
+  
PORTABARENO**

**AXIAL BASE 90°  
+  
TOOL HOLDER**



Ideale per / Suitable for  
**MiniDABtool**

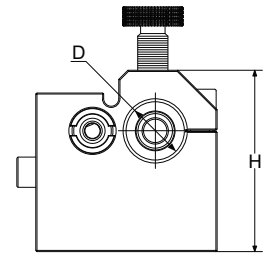
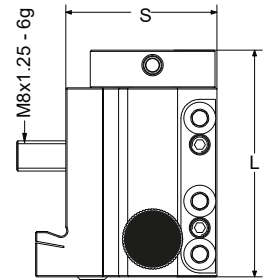

**AcquaStream**  
by COMAND TOOL

**Composizione Set / Set Composition**

Cod. PROMO	n° 1 Base / Base 90° a tua scelta / of your choice	n° 1 Portabareno / Tool Holder a tua scelta / of your choice					Prezzo / Price
<b>PRM12-0087</b>	MTS-...-C1..C-B	MTS-E9D10-B					<b>€ 259,00</b>
<b>PRM12-0088</b>	MTS-...-C1..C-B	MTS-E9D12-B					<b>€ 259,00</b>
<b>PRM12-0089</b>	MTS-...-C1..C-B	MTS-E9D16-B					<b>€ 259,00</b>
Cod. PROMO	n° 1 Base / Base 90°	n° 3 Portabareni / Tool Holders					Prezzo / Price
<b>PRM12-0134</b>	MTS-...-C1..C-B	MTS-E9D10-12-16-B					<b>€ 489,00</b>
<b>vedi lista sotto / see list below</b>							
Cod. PROMO	n° 1 Portabareno / Tool Holder	D	H	L	S	Prezzo / Price	
<b>PRM12-0090</b>	MTS-E9D10-B	10	48	60	40	<b>€ 149,00</b>	
<b>PRM12-0091</b>	MTS-E9D12-B	12	48	70	40	<b>€ 149,00</b>	
<b>PRM12-0092</b>	MTS-E9D16-B	16	48	74	40	<b>€ 149,00</b>	
Cod. PROMO	n° 3 Portabareni / Tool Holders					Prezzo / Price	
<b>PRM12-0093</b>	n° 1 MTS-E9D10-B + n° 1 MTS-E9D12-B + n° 1 MTS-E9D16-B					<b>€ 369,00</b>	

**Basi Assiali 90° da accoppiare ai Portabareno MTS / Axial Base 90° to be coupled with Tool Holder MTS**

**BMT**

- MTS-BMT45-C1C4C-B
- MTS-BMT55-C1C4C-B
- MTS-BMT65-C1C4C-B
- MTS-BMT75-C1C4C-B



**DOOSAN STATIC S1**

- MTS-DS1M-C1C4C-B



**DOOSAN STATIC S2**

- MTS-DS2M-C1C4C-B



**BIGLIA**

- MTS-BG2L-C1C4C-B



**VDI**

- MTS-VDI30-C1C-B
- MTS-VDI40-C1C-B
- MTS-VDI50-C1C-B



**POLYGONAL "C"**

- MTS-C04-C1C-B
- MTS-C05-C1C-B
- MTS-C06-C1C-B



# DABtool CS20 D20 / 25 / 32

**BARRA + TESTINA**  
**BAR + HEAD**

Barre Antivibranti D20/25/32 + Testine CS20 / Antivibration Bars D20/25/32 + Heads CS20

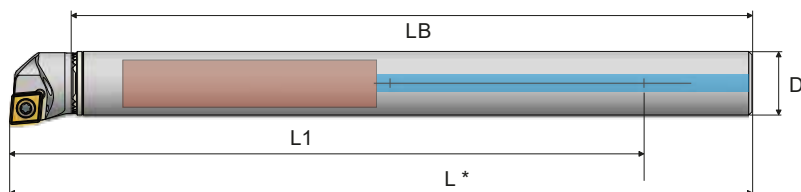

damper

AcquaStream



Boring Ratio	Barra / Bar	D	L*	L1	LB
<b>6 x D</b>	AFS20-06-180	20	200	120	180
	AFS25-06-230	25	250	150	230
	AFS32-06-300	32	320	192	300

### Composizione Set / Set Composition

Cod. PROMO	Barra / Bar	n° 1 Testina / Head CS20	Prezzo / Price
<b>PRM13-0178</b>	AFS20-06-180	A tua scelta / At your choice	<b>€ 659,00</b>
<b>PRM13-0179</b>	AFS25-06-230	A tua scelta / At your choice	<b>€ 689,00</b>
<b>PRM13-0180</b>	AFS32-06-300	A tua scelta / At your choice	<b>€ 779,00</b>

Boring Ratio	Barra / Bar	D	L*	L1	LB
<b>8 x D</b>	AFS20-08-220	20	240	160	220
	AFS25-08-280	25	300	200	280
	AFS32-08-364	32	384	256	364

### Composizione Set / Set Composition

Cod. PROMO	Barra / Bar	n° 1 Testina / Head CS20	Prezzo / Price
<b>PRM13-0181</b>	AFS20-08-220	A tua scelta / At your choice	<b>€ 709,00</b>
<b>PRM13-0182</b>	AFS25-08-280	A tua scelta / At your choice	<b>€ 759,00</b>
<b>PRM13-0183</b>	AFS32-08-364	A tua scelta / At your choice	<b>€ 829,00</b>

Boring Ratio	Barra / Bar	D	L*	L1	LB
<b>10 x D</b>	AFS20-10-260	20	280	200	260
	AFS25-10-330	25	350	250	330
	AFS32-10-428	32	448	320	428

### Composizione Set / Set Composition

Cod. PROMO	Barra / Bar	n° 1 Testina / Head CS20	Prezzo / Price
<b>PRM13-0184</b>	AFS20-10-260	A tua scelta / At your choice	<b>€ 1259,00</b>
<b>PRM13-0185</b>	AFS25-10-330	A tua scelta / At your choice	<b>€ 1359,00</b>
<b>PRM13-0186</b>	AFS32-10-428	A tua scelta / At your choice	<b>€ 1459,00</b>

\* Lunghezza variabile in funzione della testina montata  
Length may vary depending on head mounted



Elenco delle testine CS20  
List of CS20 heads see



p. 27

# DABtool CS20 Testine

Testine CS20 per Barre Antivibranti / Heads CS20 for Antivibrations Bars

**3 / 5**  
TESTINE / HEADS  
A SCELTA / OF YOUR CHOICE

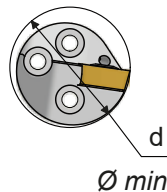
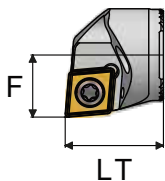

**AcquaStream**  
by COMAND TOOL

Cod. PROMO	Ordine Minimo / Minimum Order	Prezzo / Price singola testina / single heads
<b>PRM13-0196</b>	<b>3 testine / heads</b>	<b>€ 109,00</b>
<b>PRM13-0197</b>	<b>5 testine / heads</b>	<b>€ 99,00</b>



95°

CS20-SCLCR/L-09

LT	F	d min		
		AFS20	AFS25	AFS32
20,5	13	24	29	36



62,5°

CS20-SDNCR/L-11

LT	F	d min		
		AFS20	AFS25	AFS32
20,5	16	26	31	38



107,5°

CS20-SDQCR/L-07

LT	F	d min		
		AFS20	AFS25	AFS32
20,5	13	24	29	36



107,5°

CS20-SDQCR/L-11

LT	F	d min		
		AFS20	AFS25	AFS32
22,5	15	26	31	38



107,5°

CS20-SDUCR/L-07

LT	F	d min		
		AFS20	AFS25	AFS32
20,5	13	24	29	36



93°

CS20-SDUCR/L-11

LT	F	d min		
		AFS20	AFS25	AFS32
20,5	15	26	31	38



93°

CS20-STUCR/L-11

LT	F	d min		
		AFS20	AFS25	AFS32
20,5	13	24	29	36



93°

CS20-STUCR/L-16

LT	F	d min		
		AFS20	AFS25	AFS32
21	15	26	31	38



95°

CS20-SDXCR/L-11

LT	F	d min		
		AFS20	AFS25	AFS32
25	16	26	31	38



93°

CS20-SVUCR/L-11

LT	F	d min		
		AFS20	AFS25	AFS32
20,5	16	26	31	38



90°

CS20-SIR/L-16

LT	F	d min		
		AFS20	AFS25	AFS32
21,7	15	26	31	38

# DABtool CS25 6 / 8 / 10 x D

**BARRA + TESTINA**  
**BAR + HEAD**

Barre Antivibranti D25 + Testine CS25 / Antivibration Bars D25 + Heads CS25

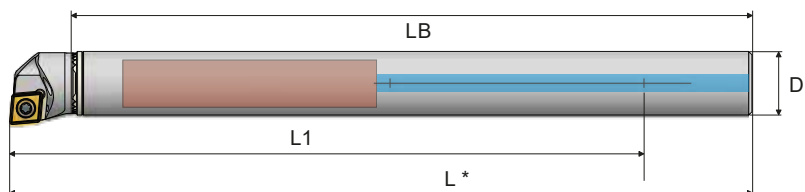

damper **AcquaStream**

**NEW**



Boring Ratio	Barra / Bar	D	L*	L1	LB
6 x D	AFS25-06-230-CS25	25	258	158	230
8 x D	AFS25-08-280-CS25	25	308	208	280
10 x D	AFS25-10-330-CS25	25	358	258	330

## Composizione Set / Set Composition

Cod. PROMO	Barra / Bar	n° 1 Testina / Head CS25	Prezzo / Price
<b>PRM13-0198</b>	AFS25-06-230-CS25	A tua scelta / At your choice	<b>€ 729,00</b>
<b>PRM13-0199</b>	AFS25-08-280-CS25	A tua scelta / At your choice	<b>€ 799,00</b>
<b>PRM13-0200</b>	AFS25-10-330-CS25	A tua scelta / At your choice	<b>€ 1399,00</b>

# DABtool CS25 Testine **NEW**

Testine CS25 per Barre Antivibranti D25 / Heads CS25 for Antivibrations Bars D25

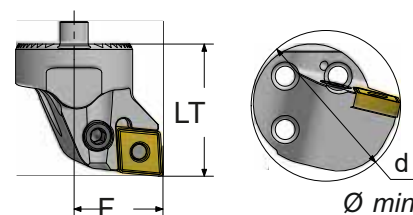

95°



93°



95°



93°



62,4°

CS25-PCLNR/L-09

LT	F	d min
28	19	32

CS25-PDUNR/L-11

LT	F	d min
28	19	32

CS25-SCLCR/L-09

LT	F	d min
28	17	32

CS25-SDUCR/L-11

LT	F	d min
28	17	32

CS25-SDXCR/L-11

LT	F	d min
22	17	32



93°



93°



93°



90°

CS25-STUCR/L-16

LT	F	d min
28	17	32

CS25-SVUBR/L-16

LT	F	d min
28	20	34

CS25-SVUCR/L-16

LT	F	d min
28	20	34

CS25-SIR/L-16

LT	F	d min
28	17	31

# DABtool CS32 6 / 8 / 10 x D

**BARRA + TESTINA**  
**BAR + HEAD**

Barre Antivibranti D32 + Testine CS32 / Antivibration Bars D32 + Heads CS32

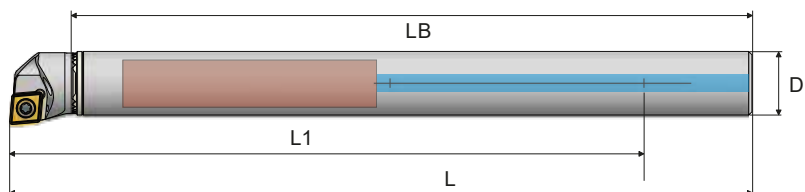

damper **AcquaStream**

**NEW**



Boring Ratio	Barra / Bar	D	L*	L1	LB
6 x D	AFS32-06-300-CS32	32	332	204	300
8 x D	AFS32-08-364-CS32	32	396	268	364
10 x D	AFS32-10-428-CS32	32	460	332	428

## Composizione Set / Set Composition

Cod. PROMO	Barra / Bar	n° 1 Testina / Head CS25	Prezzo / Price
<b>PRM13-0201</b>	AFS32-06-300-CS32	A tua scelta / At your choice	<b>€ 829,00</b>
<b>PRM13-0202</b>	AFS32-08-364-CS32	A tua scelta / At your choice	<b>€ 899,00</b>
<b>PRM13-0203</b>	AFS32-10-428-CS32	A tua scelta / At your choice	<b>€ 1519,00</b>

# DABtool CS32 Testine **NEW**

Testine CS32 per Barre Antivibranti D32 / Heads CS32 for Antivibrations Bars D32

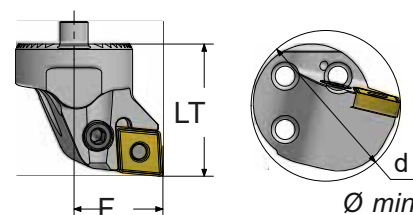

95°



93°



95°



93°



62,4°

CS32-PCLNR/L-12

CS32-PDUNR/L-11

CS32-SCLCR/L-09

CS32-SDUCR/L-11

CS32-SDXCR/L-11

LT	F	d min
32	22	40

LT	F	d min
32	22	40

LT	F	d min
32	22	40

LT	F	d min
32	22	40

LT	F	d min
26	22	40



93°



93°



93°



90°

CS32-STUCR/L-16

CS32-SVUBR/L-16

CS32-SVUCR/L-16

CS32-SIR/L-16

LT	F	d min
32	22	40

LT	F	d min
32	22	40

LT	F	d min
32	22	40

LT	F	d min
32	22	40



# DABtool CS40 D40 / 50 / 60

**BARRA + TESTINA**  
**BAR + HEAD**

Barre Antivibranti D40/50/60 + Testine CS40 / Antivibration Bars D40/50/60 + Heads CS40

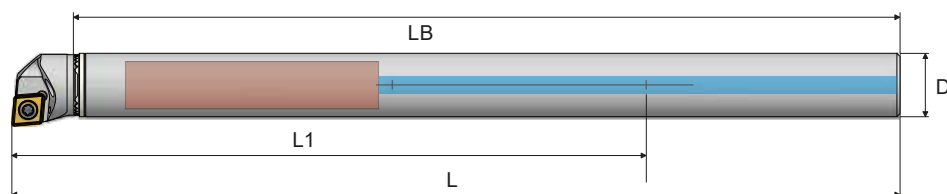

damper

AcquaStream

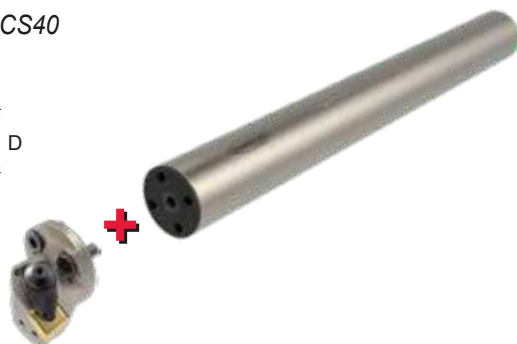

Boring Ratio	Barra / Bar	D	L*	L1	LB
<b>6 x D</b>	AFS40-06-368	40	400	240	368
	AFS50-06-468	50	500	300	468
	AFS60-06-568	60	600	360	568

### Composizione Set / Set Composition

Cod. PROMO	Barra / Bar	n° 1 Testina / Head CS40	Prezzo / Price
<b>PRM13-0187</b>	AFS40-06-368	A tua scelta / At your choice	<b>€ 889,00</b>
<b>PRM13-0188</b>	AFS50-06-468	A tua scelta / At your choice	<b>€ 1049,00</b>
<b>PRM13-0189</b>	AFS60-06-568	A tua scelta / At your choice	<b>€ 1369,00</b>

Boring Ratio	Barra / Bar	D	L*	L1	LB
<b>8 x D</b>	AFS40-08-448	40	480	320	448
	AFS50-08-568	50	600	400	568
	AFS60-08-688	60	720	480	688

### Composizione Set / Set Composition

Cod. PROMO	Barra / Bar	n° 1 Testina / Head CS40	Prezzo / Price
<b>PRM13-0190</b>	AFS40-08-448	A tua scelta / At your choice	<b>€ 989,00</b>
<b>PRM13-0191</b>	AFS50-08-568	A tua scelta / At your choice	<b>€ 1159,00</b>
<b>PRM13-0192</b>	AFS60-08-688	A tua scelta / At your choice	<b>€ 1469,00</b>

Boring Ratio	Barra / Bar	D	L*	L1	LB
<b>10 x D</b>	AFS40-10-528	40	560	400	528
	AFS50-10-668	50	700	500	668
	AFS60-10-808	60	840	600	808

### Composizione Set / Set Composition

Cod. PROMO	Barra / Bar	n° 1 Testina / Head CS40	Prezzo / Price
<b>PRM13-0193</b>	AFS40-10-528	A tua scelta / At your choice	<b>€ 1799,00</b>
<b>PRM13-0194</b>	AFS50-10-668	A tua scelta / At your choice	<b>€ 2299,00</b>
<b>PRM13-0195</b>	AFS60-10-808	A tua scelta / At your choice	<b>€ 2999,00</b>

\* Lunghezza variabile in funzione della testina montata  
Length may vary depending on head mounted



Elenco delle testine CS40  
List of CS40 heads see



p. 31

# DABtool CS40 Testine

Testine CS40 per Barre Antivibranti / Heads CS40 for Antivibrations Bars

**3 / 5**  
TESTINE / HEADS  
A SCELTA / OF YOUR CHOICE

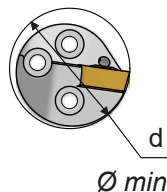
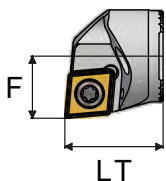

**AcquaStream**  
by COMAND TOOL

Cod. PROMO	Ordine Minimo / Minimum Order	Prezzo / Price singola testina / single heads
<b>PRM13-0204</b>	<b>3 testine / heads</b>	<b>€ 159,00</b>
<b>PRM13-0205</b>	<b>5 testine / heads</b>	<b>€ 139,00</b>



95°

CS40-DCLNR/L-12/16

LT	F	d min		
		AFS40	AFS50	AFS60
35	27	48	58	68



107,5°

CS40-DDQNR/L-15

LT	F	d min		
		AFS40	AFS50	AFS60
35	27	48	58	68



93°

CS40-DDUNR/L-15

LT	F	d min		
		AFS40	AFS50	AFS60
35	27	48	58	68



93°

CS40-DTUNR/L-16/22

LT	F	d min		
		AFS40	AFS50	AFS60
16	22	48	58	68
35	40			



93°

CS40-DVUNR/L-16

LT	F	d min		
		AFS40	AFS50	AFS60
35	29	50	60	70



95°

CS40-DWLNRL/L-08

LT	F	d min		
		AFS40	AFS50	AFS60
35	27	48	58	68



95°

CS40-SCLCR/L-12

LT	F	d min		
		AFS40	AFS50	AFS60
32	27	49	59	69



107,5°

CS40-SDQCR/L-11

LT	F	d min		
		AFS40	AFS50	AFS60
32	27	48	58	68



93°

CS40-SDUCR/L-11/15

LT	F	d min		
		AFS40	AFS50	AFS60
32	27	49	59	69



93°

CS40-STUCR/L-16

LT	F	d min		
		AFS40	AFS50	AFS60
32	27	49	59	69



93°

CS40-SVUBR/L-16

LT	F	d min		
		AFS40	AFS50	AFS60
32	27	49	59	69



93°

CS40-SVUCR/L-11/16

LT	F	d min		
		AFS40	AFS50	AFS60
32	27	49	59	69



110°

CS40-SVXCR/L-16

LT	F	d min		
		AFS40	AFS50	AFS60
40	27	48	58	68



90°

CS40-DIR/L-16/22

LT	F	d min		
		AFS40	AFS50	AFS60
16	22	49	59	69
35	40			



Troncatura  
Grooving

90°

CS40-CIGR/L-20/30/40/50-11

LT	F	d min		
		AFS40	AFS50	AFS60
25	32	52,5	62,5	72,5



Portautensile  
Toolholder

CS40-PU10R/L

LT	d min		
	AFS40	AFS50	AFS60
32	-	-	-

# Scanalatura Modulare

Frontale / Modular Face Grooving

**UTENSILE + CARTUCCE + INSERTI**  
**TOOLHOLDER + CARTRIDGES + INSERTS**

**Acqua**  
by COMAND TOOL

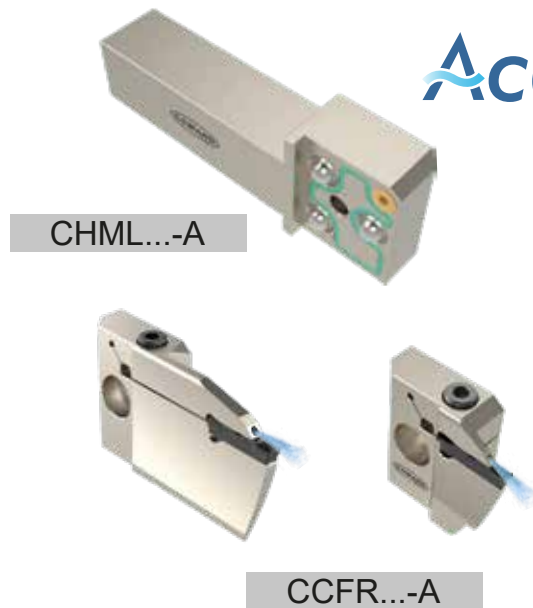
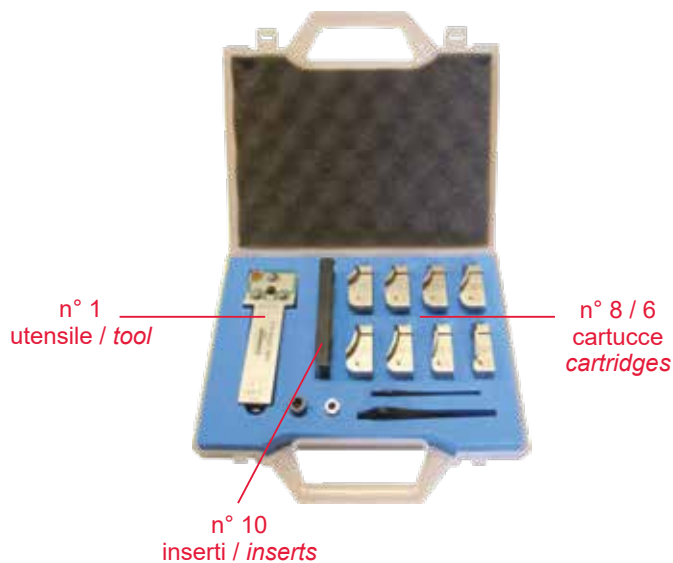

## SERIE COMBINATA / COMBINED SERIES

CARTUCCE / CARTRIDGES  
CORTE / SHORT ● + LUNGHE / LONG ●

Composizione Set / Set Composition

Cod. PROMO	n° 1 Utensile / Tool	n° 8 Cartucce / Cartridges		n° 10 Inserti	Prezzo / Price
		Corte / Short	Lunghe / Long		
PRM08-0097	CHML 2020K 34-A	CCFR 2530 30-10-A CCFR 3038 30-10-A	CCFR 6075 30-20-A CCFR 75100 30-20-A	<b>3 mm</b> CTSN2230GT PG4540	€ 769,00
PRM08-0098	CHML 2525M 34-A	CCFR 3848 30-10-A CCFR 4860 30-10-A	CCFR 100200 30-20-A CCFR 200-> 30-20-A		€ 779,00
PRM08-0099	CHMR 2020K 34-B	CCFL 2530 30-10-B CCFL 3038 30-10-B	CCFL 6075 30-20-B CCFL 75100 30-20-B		€ 769,00
PRM08-0100	CHMR 2525M 34-B	CCFL 3848 30-10-B CCFL 4860 30-10-B	CCFL 100200 30-20-B CCFL 200-> 30-20-B		€ 779,00

Composizione Set / Set Composition

Cod. PROMO	n° 1 Utensile / Tool	n° 6 Cartucce / Cartridges		n° 10 Inserti	Prezzo / Price
		Corte / Short	Lunghe / Long		
PRM08-0101	CHML 2020K 34-A	CCFR 3048 40-12-A CCFR 4860 40-12-A	CCFR 75100 40-24-A CCFR 100150 40-24-A	<b>4 mm</b> CTSN2540GT PG4540	€ 639,00
PRM08-0102	CHML 2525M 34-A	CCFR 6075 40-12-A	CCFR 150-> 40-24-A		€ 649,00
PRM08-0103	CHMR 2020K 34-B	CCFL 3048 40-12-B CCFL 4860 40-12-B	CCFL 75100 40-24-B CCFL 100150 40-24-B		€ 639,00
PRM08-0104	CHMR 2525M 34-B	CCFL 6075 40-12-B	CCFL 150-> 40-24-B		€ 649,00

# Scanalatura Modulare

Frontale / Modular Face Grooving

## Stream



CHMR...-B

PG4540



Compra 1 Utensile  
Buy 1 Toolholders  
**10** INSERTI GRATIS  
FREE INSERTS

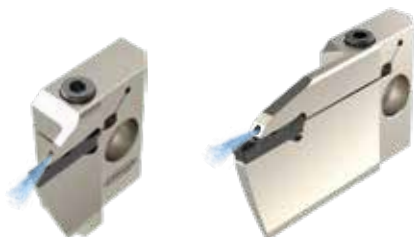

CCFL...-B

GT

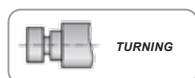

### SERIE COMBINATA / COMBINED SERIES

CARTUCCE / CARTRIDGES  
CORTE / SHORT ● + LUNGHE / LONG ●

Composizione Set / Set Composition

Cod. PROMO	n° 1 Utensile / Tool	n° 6 Cartucce / Cartridges		n° 10 Inserti	Prezzo / Price
		Corte / Short	Lunghe / Long		
PRM08-0105	CHML 2020K 34-A	CCFR 4255 50-22-A CCFR 5575 50-22-A	CCFR 130200 50-45-A CCFR 200450 50-45-A	5 mm CTSN2550GT PG4540	€ 639,00
PRM08-0106	CHML 2525M 34-A	CCFR 75130 50-22-A	CCFR 450-> 50-45-A		€ 649,00
PRM08-0107	CHMR 2020K 34-B	CCFL 4255 50-22-B CCFL 5575 50-22-B	CCFL 130200 50-45-B CCFL 200450 50-45-B		€ 639,00
PRM08-0108	CHMR 2525M 34-B	CCFL 75130 50-22-B	CCFL 450-> 50-45-B		€ 649,00

Composizione Set / Set Composition

Cod. PROMO	n° 1 Utensile / Tool	n° 6 Cartucce / Cartridges		n° 10 Inserti	Prezzo / Price
		Corte / Short	Lunghe / Long		
PRM08-0109	CHML 2020K 34-A	CCFR 4255 60-22-A CCFR 5575 60-22-A	CCFR 130200 60-45-A CCFR 200450 60-45-A	6 mm CTSN2560GT PG4540	€ 639,00
PRM08-0110	CHML 2525M 34-A	CCFR 75130 60-22-A	CCFR 450-> 60-45-A		€ 649,00
PRM08-0111	CHMR 2020K 34-B	CCFL 4255 60-22-B CCFL 5575 60-22-B	CCFL 130200 60-45-B CCFL 200450 60-45-B		€ 639,00
PRM08-0112	CHMR 2525M 34-B	CCFL 75130 60-22-B	CCFL 450-> 60-45-B		€ 649,00

# Scanalatura Modulare

Frontale / Modular Face Grooving

**UTENSILE + CARTUCCE + INSERTI**  
**TOOLHOLDER + CARTRIDGES + INSERTS**

**AcquaStream**  
by COMAND TOOL



n° 1  
utensile / tool

CHML...-A

n° 4 / 6 / 8  
cartucce  
cartridges

CHMR...-B

CCFR...-A

CCFL...-B

GT

PG4540

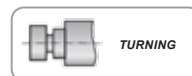

## SERIE CARTUCCE CORTE / SHORT CARTRIDGES SERIES

Composizione Set / Set Composition

Cod. PROMO	n° 1 Utensile / Tool	n° 8 Cartucce / Cartridges	n° 10 Inserti	Prezzo / Price
PRM08-0113	CHML 2020K 34-A	CCFR...20-08-A	<b>2 mm</b>	€ 769,00
PRM08-0114	CHML 2525M 34-A	CCFR...20-08-A		€ 779,00
PRM08-0115	CHMR 2020K 34-B	CCFL...20-08-B	CTSN2220GT PG4540	€ 769,00
PRM08-0116	CHMR 2525M 34-B	CCFL...20-08-B		€ 779,00

Cod. PROMO	n° 1 Utensile / Tool	n° 8 Cartucce / Cartridges	n° 10 Inserti	Prezzo / Price
PRM08-0001	CHML 2020K 34-A	CCFR...30-10-A	<b>3 mm</b>	€ 769,00
PRM08-0002	CHML 2525M 34-A	CCFR...30-10-A		€ 779,00
PRM08-0003	CHMR 2020K 34-B	CCFL...30-10-B	CTSN2230GT PG4540	€ 769,00
PRM08-0004	CHMR 2525M 34-B	CCFL...30-10-B		€ 779,00

Cod. PROMO	n° 1 Utensile / Tool	n° 6 Cartucce / Cartridges	n° 10 Inserti	Prezzo / Price
PRM08-0005	CHML 2020K 34-A	CCFR...40-12-A	<b>4 mm</b>	€ 639,00
PRM08-0006	CHML 2525M 34-A	CCFR...40-12-A		€ 649,00
PRM08-0007	CHMR 2020K 34-B	CCFL...40-12-B	CTSN2540GT PG4540	€ 639,00
PRM08-0008	CHMR 2525M 34-B	CCFL...40-12-B		€ 649,00

## SERIE CARTUCCE LUNGHE / LONG CARTRIDGES SERIES

Composizione Set / Set Composition

Cod. PROMO	n° 1 Utensile / Tool	n° 4 Cartucce / Cartridges	n° 10 Inserti	Prezzo / Price
PRM08-0009	CHML 2020K 34-A	CCFR...30-20-A	<b>3 mm</b>	€ 499,00
PRM08-0010	CHML 2525M 34-A	CCFR...30-20-A		€ 509,00
PRM08-0011	CHMR 2020K 34-B	CCFL...30-20-B	CTSN2230GT PG4540	€ 499,00
PRM08-0012	CHMR 2525M 34-B	CCFL...30-20-B		€ 509,00

Cod. PROMO	n° 1 Utensile / Tool	n° 6 Cartucce / Cartridges	n° 10 Inserti	Prezzo / Price
PRM08-0013	CHML 2020K 34-A	CCFR...40-24-A	<b>4 mm</b>	€ 639,00
PRM08-0014	CHML 2525M 34-A	CCFR...40-24-A		€ 649,00
PRM08-0015	CHMR 2020K 34-B	CCFL...40-24-B	CTSN2540GT PG4540	€ 639,00
PRM08-0016	CHMR 2525M 34-B	CCFL...40-24-B		€ 649,00



# Scanalatura Modulare

Radiale / Modular Radial Grooving

AcquaStream  
by COMAND TOOL



n° 1 utensile / tool

n° 10 inserti / inserts

n° 3 cartucce cartridges

CHML...-A



CHMR...-B



CCGL...-A



CCGR...-B



GT

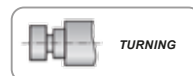

Compra 1 Utensile  
Buy 1 Toolholders  
**10** INSERTI GRATIS  
FREE INSERTS

PG4540



## CARTUCCE SERIE COMBINATA / COMBINED CARTRIDGES SERIES

CARTUCCE / CARTRIDGES  
CORTE / SHORT ● + LUNGHE / LONG ● + EXTRA-LUNGHE / EXTRA-LONG ● **NEW**

### Composizione Set / Set Composition

Cod. PROMO	n° 1 Utensile / Tool	n° 3 Cartucce / Cartridges	n° 10 Inserti	Prezzo / Price
PRM08-0021	CHML 2020K 34-A	CCGL 30 10-A ●	<b>3 mm</b> CTSN2230GT PG4540	€ 429,00
PRM08-0022	CHML 2525M 34-A	CCGL 30 20-A ●		€ 439,00
PRM08-0023	CHMR 2020K 34-B	<b>NEW</b> CCGL 30 30-A ●		€ 429,00
PRM08-0024	CHMR 2525M 34-B	CCGR 30 10-B ● CCGR 30 20-B ● <b>NEW</b> CCGR 30 30-B ●		€ 439,00

Cod. PROMO	n° 1 Utensile / Tool	n° 3 Cartucce / Cartridges	n° 10 Inserti	Prezzo / Price
PRM08-0025	CHML 2020K 34-A	CCGL 40 12-A ●	<b>4 mm</b> CTSN2540GT PG4540	€ 439,00
PRM08-0026	CHML 2525M 34-A	CCGL 40 24-A ●		€ 449,00
PRM08-0027	CHMR 2020K 34-B	<b>NEW</b> CCGL 40 36-A ●		€ 439,00
PRM08-0028	CHMR 2525M 34-B	CCGR 40 12-B ● CCGR 40 24-B ● <b>NEW</b> CCGR 40 36-B ●		€ 449,00

Cod. PROMO	n° 1 Utensile / Tool	n° 3 Cartucce / Cartridges	n° 10 Inserti	Prezzo / Price
PRM08-0029	CHML 2020K 34-A	CCGL 50 15-A ●	<b>5 mm</b> CTSN2550GT PG4540	€ 449,00
PRM08-0030	CHML 2525M 34-A	CCGL 50 30-A ●		€ 459,00
PRM08-0031	CHMR 2020K 34-B	<b>NEW</b> CCGL 50 45-A ●		€ 449,00
PRM08-0032	CHMR 2525M 34-B	CCGR 50 15-B ● CCGR 50 30-B ● <b>NEW</b> CCGR 50 45-B ●		€ 459,00

# Scanalatura Modulare

**NEW**

**UTENSILE + CARTUCCE**  
**TOOLHOLDER + CARTRIDGES**

Radiale / Modular Radial Grooving

**AcquaStream**  
by COMAND TOOL



n° 1  
utensile / tool

n° 2  
cartucce  
cartridges



GY..0300  
GY..0400

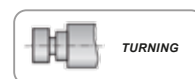

CARTUCCE COMPATIBILI CON INSERTO:  
COMPATIBLE CARTRIDGES WITH INSERT:

**MITSUBISHI**

CARTUCCE / CARTRIDGES  
CORTE / SHORT ● + LUNGHE / LONG ●

INSERTI NON INCLUSI  
NELLA PROMOZIONE  
INSERTS NOT INCLUDED  
IN THE PROMOTION

Composizione Set / Set Composition

Cod. PROMO	n° 1 Utensile / Tool	n° 2 Cartucce / Cartridges	Inserto / Insert	Prezzo / Price
PRM08-0141	CHML 2020K 34-A	MCGL 30 10-A ●	<b>3 mm</b>	€ 379,00
PRM08-0142	CHML 2525M 34-A	MCGL 30 20-A ●		€ 389,00
PRM08-0143	CHMR 2020K 34-B	MCGR 30 10-B ●	GY..0300	€ 379,00
PRM08-0144	CHMR 2525M 34-B	MCGR 30 20-B ●		€ 389,00

Cod. PROMO	n° 1 Utensile / Tool	n° 2 Cartucce / Cartridges	Inserto / Insert	Prezzo / Price
PRM08-0145	CHML 2020K 34-A	MCGL 40 12-A ●	<b>4 mm</b>	€ 389,00
PRM08-0146	CHML 2525M 34-A	MCGL 40 24-A ●		€ 399,00
PRM08-0147	CHMR 2020K 34-B	MCGR 40 12-B ●	GY..0400	€ 389,00
PRM08-0148	CHMR 2525M 34-B	MCGR 40 24-B ●		€ 399,00

# Scanalatura Modulare

**NEW**

**UTENSILE + CARTUCCE**  
**TOOLHOLDER + CARTRIDGES**

Radiale / Modular Radial Grooving

**AcquaStream**  
by COMAND TOOL



n° 1  
utensile / tool

n° 2  
cartucce  
cartridges



GI..3.00  
GI..4.00  
GI..5.00

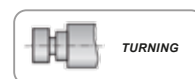

CARTUCCE COMPATIBILI CON INSERTO:  
COMPATIBLE CARTRIDGES WITH INSERT:

**ISCAR**

CARTUCCE / CARTRIDGES  
CORTE / SHORT ● + LUNGHE / LONG ●

INSERTI NON INCLUSI  
NELLA PROMOZIONE  
INSERTS NOT INCLUDED  
IN THE PROMOTION

## Composizione Set / Set Composition

Cod. PROMO	n° 1 Utensile / Tool	n° 2 Cartucce / Cartridges	Inserto / Insert	Prezzo / Price
PRM08-0149	CHML 2020K 34-A	ICGL 30 10-A ●	<b>3 mm</b>	€ 379,00
PRM08-0150	CHML 2525M 34-A	ICGL 30 20-A ●		€ 389,00
PRM08-0151	CHMR 2020K 34-B	ICGR 30 10-B ●	GI..3.00	€ 379,00
PRM08-0152	CHMR 2525M 34-B	ICGR 30 20-B ●		€ 389,00

Cod. PROMO	n° 1 Utensile / Tool	n° 2 Cartucce / Cartridges	Inserto / Insert	Prezzo / Price
PRM08-0153	CHML 2020K 34-A	ICGL 40 12-A ●	<b>4 mm</b>	€ 389,00
PRM08-0154	CHML 2525M 34-A	ICGL 40 24-A ●		€ 399,00
PRM08-0155	CHMR 2020K 34-B	ICGR 40 12-B ●	GI..4.00	€ 389,00
PRM08-0156	CHMR 2525M 34-B	ICGR 40 24-B ●		€ 399,00

Cod. PROMO	n° 1 Utensile / Tool	n° 2 Cartucce / Cartridges	Inserto / Insert	Prezzo / Price
PRM08-0157	CHML 2020K 34-A	ICGL 50 15-A ●	<b>5 mm</b>	€ 409,00
PRM08-0158	CHML 2525M 34-A	ICGL 50 30-A ●		€ 419,00
PRM08-0159	CHMR 2020K 34-B	ICGR 50 15-B ●	GI..5.00	€ 409,00
PRM08-0160	CHMR 2525M 34-B	ICGR 50 30-B ●		€ 419,00

# Scanalatura Modulare

**NEW**

**UTENSILE + CARTUCCE**  
**TOOLHOLDER + CARTRIDGES**

Radiale / Modular Radial Grooving

**AcquaStream**  
by COMAND TOOL



n° 1 utensile / tool

n° 2 cartucce cartridges



A4..0300  
A4..0400  
A4..0500

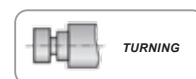

CARTUCCE COMPATIBILI CON INSERTO:  
COMPATIBLE CARTRIDGES WITH INSERT:

**KENNAMETAL**

CARTUCCE / CARTRIDGES  
CORTE / SHORT ● + LUNGHE / LONG ●

INSERTI NON INCLUSI  
NELLA PROMOZIONE  
INSERTS NOT INCLUDED  
IN THE PROMOTION

Composizione Set / Set Composition

Cod. PROMO	n° 1 Utensile / Tool	n° 2 Cartucce / Cartridges	Inserto / Insert	Prezzo / Price
PRM08-0161	CHML 2020K 34-A	KCGL 30 10-A ●	<b>3 mm</b>	€ 379,00
PRM08-0162	CHML 2525M 34-A	KCGL 30 20-A ●		€ 389,00
PRM08-0163	CHMR 2020K 34-B	KCGR 30 10-B ●	A4..0300	€ 379,00
PRM08-0164	CHMR 2525M 34-B	KCGR 30 20-B ●		€ 389,00

Cod. PROMO	n° 1 Utensile / Tool	n° 2 Cartucce / Cartridges	Inserto / Insert	Prezzo / Price
PRM08-0165	CHML 2020K 34-A	KCGL 40 12-A ●	<b>4 mm</b>	€ 389,00
PRM08-0166	CHML 2525M 34-A	KCGL 40 24-A ●		€ 399,00
PRM08-0167	CHMR 2020K 34-B	KCGR 40 12-B ●	A4..0400	€ 389,00
PRM08-0168	CHMR 2525M 34-B	KCGR 40 24-B ●		€ 399,00

Cod. PROMO	n° 1 Utensile / Tool	n° 2 Cartucce / Cartridges	Inserto / Insert	Prezzo / Price
PRM08-0169	CHML 2020K 34-A	KCGL 50 15-A ●	<b>5 mm</b>	€ 409,00
PRM08-0170	CHML 2525M 34-A	KCGL 50 30-A ●		€ 419,00
PRM08-0171	CHMR 2020K 34-B	KCGR 50 15-B ●	A4..0500	€ 409,00
PRM08-0172	CHMR 2525M 34-B	KCGR 50 30-B ●		€ 419,00

# Scanalatura - Troncatura Integrale

Utensili per Scanalatura - Troncatura Esterna / Holder for Grooving and Parting-Off

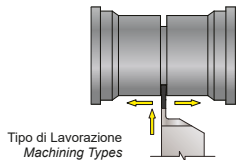

Tipo di Lavorazione  
Machining Types

**Compra 1 Utensile  
Buy 1 Toolholders**  
**10 INSERTI GRATIS  
FREE INSERTS**

**PG4540**



**GT**



## Composizione Set / Set Composition

Cod. PROMO	Utensile / Tool	n° 10 Inserti / Inserts	T-max	Insert W	Prezzo / Price
PRM08-0037	CEGR 1616K 20-10	CTSN2220GT PG4540	10	2,0	€ 169,00
PRM08-0038	CEGR 2020K 20-12	CTSN2220GT PG4540	12	2,0	€ 169,00
PRM08-0039	CEGR 2020K 20-18	CTSN2220GT PG4540	18	2,0	€ 169,00
PRM08-0040	CEGR 2525M 20-12	CTSN2220GT PG4540	12	2,0	€ 169,00
PRM08-0041	CEGR 2525M 20-18	CTSN2220GT PG4540	18	2,0	€ 169,00
PRM08-0042	CEGR 1616K 30-14	CTSN2230GT PG4540	14	3,0	€ 179,00
PRM08-0043	CEGR 2020K 30-12	CTSN2230GT PG4540	12	3,0	€ 179,00
PRM08-0044	CEGR 2020K 30-18	CTSN2230GT PG4540	18	3,0	€ 179,00
PRM08-0045	CEGR 2525M 30-12	CTSN2230GT PG4540	12	3,0	€ 179,00
PRM08-0046	CEGR 2525M 30-18	CTSN2230GT PG4540	18	3,0	€ 179,00
PRM08-0047	CEGR 3232P 30-18	CTSN2230GT PG4540	18	3,0	€ 179,00
PRM08-0048	CEGR 2020K 40-12	CTSN2540GT PG4540	12	4,0	€ 189,00
PRM08-0049	CEGR 2020K 40-20	CTSN2540GT PG4540	20	4,0	€ 189,00
PRM08-0050	CEGR 2525M 40-12	CTSN2540GT PG4540	12	4,0	€ 189,00
PRM08-0051	CEGR 2525M 40-20	CTSN2540GT PG4540	20	4,0	€ 189,00
PRM08-0052	CEGR 3232P 40-20	CTSN2540GT PG4540	20	4,0	€ 189,00
PRM08-0053	CEGL 1616K 20-10	CTSN2220GT PG4540	10	2,0	€ 169,00
PRM08-0054	CEGL 2020K 20-12	CTSN2220GT PG4540	12	2,0	€ 169,00
PRM08-0055	CEGL 2020K 20-18	CTSN2220GT PG4540	18	2,0	€ 169,00
PRM08-0056	CEGL 2525M 20-12	CTSN2220GT PG4540	12	2,0	€ 169,00
PRM08-0057	CEGL 2525M 20-18	CTSN2220GT PG4540	18	2,0	€ 169,00
PRM08-0058	CEGL 1616K 30-14	CTSN2230GT PG4540	14	3,0	€ 179,00
PRM08-0059	CEGL 2020K 30-12	CTSN2230GT PG4540	12	3,0	€ 179,00
PRM08-0060	CEGL 2020K 30-18	CTSN2230GT PG4540	18	3,0	€ 179,00
PRM08-0061	CEGL 2525M 30-12	CTSN2230GT PG4540	12	3,0	€ 179,00
PRM08-0062	CEGL 2525M 30-18	CTSN2230GT PG4540	18	3,0	€ 179,00
PRM08-0063	CEGL 3232P 30-18	CTSN2230GT PG4540	18	3,0	€ 179,00
PRM08-0064	CEGL 2020K 40-12	CTSN2540GT PG4540	12	4,0	€ 189,00
PRM08-0065	CEGL 2020K 40-20	CTSN2540GT PG4540	20	4,0	€ 189,00
PRM08-0066	CEGL 2525M 40-12	CTSN2540GT PG4540	12	4,0	€ 189,00
PRM08-0067	CEGL 2525M 40-20	CTSN2540GT PG4540	20	4,0	€ 189,00
PRM08-0068	CEGL 3232P 40-20	CTSN2540GT PG4540	20	4,0	€ 189,00



# Scanalatura - Troncatura Integrale

Utensili per Scanalatura - Troncatura Esterna / Holder for Grooving and Parting-Off

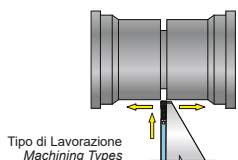

Tipo di Lavorazione  
Machining Types

**Compra 1 Utensile  
Buy 1 Toolholders**  
**10 INSERTI GRATIS  
FREE INSERTS**

PG4540



GT

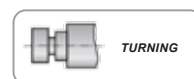

## Composizione Set / Set Composition

Cod. PROMO	Utensile / Tool	n° 10 Inserti / Inserts	T-max	Insert W	Prezzo / Price
PRM08-0069	A-CEPR-1010X 20-10	CTSN2220GT PG4540	10	2,0	€ 189,00
PRM08-0070	A-CEPR-1212K 20-12	CTSN2220GT PG4540	12	2,0	€ 189,00
PRM08-0071	A-CEPR-1212K 30-12	CTSN2230GT PG4540	12	3,0	€ 199,00
PRM08-0072	A-CEPR-1616K 20-12	CTSN2220GT PG4540	12	2,0	€ 199,00
PRM08-0073	A-CEPR-1616K 20-18	CTSN2220GT PG4540	18	2,0	€ 199,00
PRM08-0074	A-CEPR-1616K 30-12	CTSN2230GT PG4540	12	3,0	€ 209,00
PRM08-0075	A-CEPR-1616K 30-18	CTSN2230GT PG4540	18	3,0	€ 209,00
PRM08-0076	A-CEPR-2020K 20-18	CTSN2220GT PG4540	18	2,0	€ 199,00
PRM08-0077	A-CEPR-2020K 30-21	CTSN2230GT PG4540	21	3,0	€ 209,00
PRM08-0078	A-CEPR-2525K 30-21	CTSN2230GT PG4540	21	3,0	€ 219,00

## Composizione Set / Set Composition

Cod. PROMO	Utensile / Tool	n° 10 Inserti / Inserts	T-max	Insert W	Prezzo / Price
PRM08-0079	A-CEPL-1010X 20-10	CTSN2220GT PG4540	10	2,0	€ 189,00
PRM08-0080	A-CEPL-1212K 20-12	CTSN2220GT PG4540	12	2,0	€ 189,00
PRM08-0081	A-CEPL-1212K 30-12	CTSN2230GT PG4540	12	3,0	€ 199,00
PRM08-0082	A-CEPL-1616K 20-12	CTSN2220GT PG4540	12	2,0	€ 199,00
PRM08-0083	A-CEPL-1616K 20-18	CTSN2220GT PG4540	18	2,0	€ 199,00
PRM08-0084	A-CEPL-1616K 30-12	CTSN2230GT PG4540	12	3,0	€ 209,00
PRM08-0085	A-CEPL-1616K 30-18	CTSN2230GT PG4540	18	3,0	€ 209,00
PRM08-0086	A-CEPL-2020K 20-18	CTSN2220GT PG4540	18	2,0	€ 199,00
PRM08-0087	A-CEPL-2020K 30-21	CTSN2230GT PG4540	21	3,0	€ 209,00
PRM08-0088	A-CEPL-2525K 30-21	CTSN2230GT PG4540	21	3,0	€ 219,00



# Lama per Troncare

**LAMA + PORTALAMA + INSERTI**  
BLADE + TOOL HOLDER + INSERTS

Lama per Troncare con refrigerante / Cutting Blade with through coolant

AcquaStream  
by COMAND TOOL

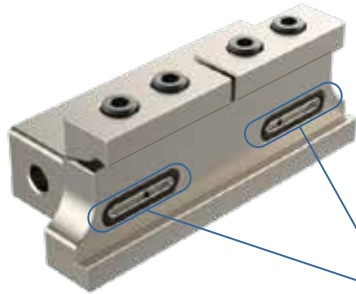
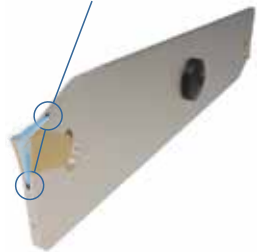

AcquaStream  
by COMAND TOOL

Compra 1 Lama / Buy 1 Cutting Blade  
**PORTALAMA + INSERTI**  
**TOOLHOLDER + INSERTS**  
**GRATIS / FREE**

CG4125



Composizione Set / Set Composition

Cod. PROMO	Utensile / Tool	Portalama / Tool Holder	n° 10 Inserti / Inserts	Prezzo / Price
PRM08-0117	A-SGIH 32-3	A-PLC 25-32	GTN3 GM CG4125	€ 219,00
PRM08-0118	A-SGIH 32-4	A-PLC 25-32	GTN4 GM CG4125	€ 219,00

# Lama per Troncare

**LAMA + CHIAVE + INSERTI**  
BLADE + KEY + INSERTS

Lama per Troncare / Cutting Blade



Compra 1 Lama  
Buy 1 Cutting Blade  
**10 INSERTI GRATIS**  
**FREE INSERTS**

PG4345



GP





Composizione Set / Set Composition

Cod. PROMO	Utensile / Tool	Chiave / Key	n° 10 Inserti / Inserts	Prezzo / Price
PRM08-0089	LACG 26-3	CLG 480	CTSN2230GP PG4345	€ 169,00
PRM08-0090	LACG 26-4	CLG 480	CTSN2540GP PG4345	€ 169,00
PRM08-0091	LACG 32-3	CLG 480	CTSN2230GP PG4345	€ 169,00
PRM08-0092	LACG 32-4	CLG 480	CTSN2540GP PG4345	€ 169,00

# Inserti Monolaterali

Inserti Monolaterali per Troncatura e Scanalatura / *Monolateral Inserts for Grooving and Parting-Off*

Inserti / Inserts	Codice Inserto / Insert Code	Prezzo per singolo Inserto / Single Insert price	
		Ordine minimo / Minimum order n° 50 pz	Ordine minimo / Minimum order n° 100 pz
<b>GP</b> 	CTSN1020GP PG4345	€ 8,00	€ 7,00
	CTSN1030GP PG4345		
	CTSN1240GP PG4345		
<b>GT</b> 	CTSN1020GT PG4540	€ 8,00	€ 7,00
	CTSN1030GT PG4540		
	CTSN1240GT PG4540		

## Troncatura Monolaterale

*Monolateral Parting-Off*



**AcquaStream**  
by COMAND TOOL

**Compra 1 Utensile  
Buy 1 Toolholders**  
**10 INSERTI GRATIS  
FREE INSERTS**

**PG4345**



**GP**



W

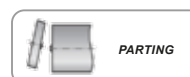

Composizione Set / Set Composition

Cod. PROMO	Utensile / Tool	n° 10 Inserti / Inserts	T-max	Insert W	Prezzo / Price
<b>PRM08-0119</b>	A-CEGR 2020K 30-26	CTSN1030GP PG4345	26	3,0	€ 149,00
<b>PRM08-0120</b>	A-CEGR 2020K 30-33	CTSN1030GP PG4345	33	3,0	€ 149,00
<b>PRM08-0137</b>	A-CEGR 2525M 30-26	CTSN1030GP PG4345	26	3,0	€ 169,00
<b>PRM08-0138</b>	A-CEGR 2525M 30-33	CTSN1030GP PG4345	33	3,0	€ 169,00
<b>PRM08-0121</b>	A-CEGR 2525M 40-28	CTSN1240GP PG4345	28	4,0	€ 159,00
<b>PRM08-0122</b>	A-CEGR 2525M 40-36	CTSN1240GP PG4345	36	4,0	€ 159,00
<b>PRM08-0123</b>	A-CEGL 2020K 30-26	CTSN1030GP PG4345	26	3,0	€ 149,00
<b>PRM08-0124</b>	A-CEGL 2020K 30-33	CTSN1030GP PG4345	33	3,0	€ 149,00
<b>PRM08-0139</b>	A-CEGL 2525M 30-26	CTSN1030GP PG4345	26	3,0	€ 169,00
<b>PRM08-0140</b>	A-CEGL 2525M 30-33	CTSN1030GP PG4345	33	3,0	€ 169,00
<b>PRM08-0125</b>	A-CEGL 2525M 40-28	CTSN1240GP PG4345	28	4,0	€ 159,00
<b>PRM08-0126</b>	A-CEGL 2525M 40-36	CTSN1240GP PG4345	36	4,0	€ 159,00

# Mini-Scanalatura

Mini-Grooving

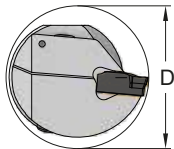

**AcquaStream**  
by COMAND TOOL

**Compra 1 Utensile  
Buy 1 Toolholders**  
**10 INSERTI GRATIS  
FREE INSERTS**

PG4540

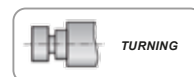

Composizione Set / Set Composition

Cod. PROMO	Utensile / Tool	n° 10 Inserti / Inserts	D	T-max	Insert W	Prezzo / Price
PRM08-0127	CIGR 0012K 20	CTSN1020GT PG4540	16	5	2,0	€ 169,00
PRM08-0128	CIGR 0012K 30	CTSN1030GT PG4540	16	5	3,0	€ 169,00
PRM08-0129	CIGR 0016M 20	CTSN1020GT PG4540	20	6	2,0	€ 189,00
PRM08-0130	CIGR 0016M 30	CTSN1030GT PG4540	20	6	3,0	€ 189,00
PRM08-0131	CIGL 0012K 20	CTSN1020GT PG4540	16	5	2,0	€ 169,00
PRM08-0132	CIGL 0012K 30	CTSN1030GT PG4540	16	5	3,0	€ 169,00
PRM08-0133	CIGL 0016M 20	CTSN1020GT PG4540	20	6	2,0	€ 189,00
PRM08-0134	CIGL 0016M 30	CTSN1030GT PG4540	20	6	3,0	€ 189,00

# Scanalatura

Utensili per Scanalatura Interna / Holder for Internal Grooving

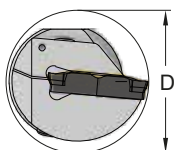

**AcquaStream**  
by COMAND TOOL

**Compra 1 Utensile  
Buy 1 Toolholders**  
**10 INSERTI GRATIS  
FREE INSERTS**

PG4540



Composizione Set / Set Composition

Cod. PROMO	Utensile / Tool	n° 10 Inserti / Inserts	D	T-max	Insert W	Prezzo / Price
PRM08-0093	CIGR 0020Q 30	CTSN2230GT PG4540	25	7	3,0	€ 229,00
PRM08-0094	CIGR 0020Q 40	CTSN2540GT PG4540	28	9	4,0	€ 229,00
PRM08-0095	CIGR 0025R 30	CTSN2230GT PG4540	32	9	3,0	€ 249,00
PRM08-0096	CIGR 0025R 40	CTSN2540GT PG4540	32	9	4,0	€ 249,00
PRM08-0135	CIGR 0032S 30	CTSN2230GT PG4540	38	11	3,0	€ 289,00
PRM08-0136	CIGR 0032S 40	CTSN2540GT PG4540	38	11	4,0	€ 289,00

# Tornitura Esterna

AcquaStream

Utensili per Tornitura Esterna AcquaStream / External Turning Tools AcquaStream

**3 / 5**  
A SCELTA  
OF YOUR CHOICE

**INSERTI NON INCLUSI NELLA PROMO / INSERTS NOT INCLUDED IN PROMO**

Cod. PROMO	Ordine Minimo / Minimum Order	Prezzo / Price singolo utensile / single tool
PRM01-0116	3 utensili / tools	€ 65,00
PRM01-0117	5 utensili / tools	€ 55,00

## D-System



A-DCLNL/R 2020K 12



A-DCLNL/R 2525M 12



A-DDJNL/R 2020K 15



A-DDJNL/R 2525M 15



A-DTJNL/R 2020K 16



A-DTJNL/R 2525M 16



A-DWLNL/R 2020K 08



A-DWLNL/R 2525M 08

## **NEW** S-System



A-SCLCL/R 2020K 09



A-SCLCL/R 2525M 09



A-SDJCL/R 2020K 11



A-SDJCL/R 2525M 11

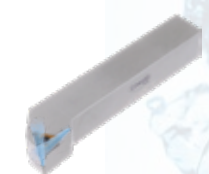

A-STJCL/R 2020K 16

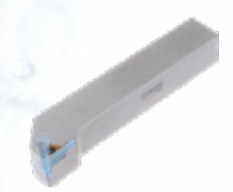

A-STJCL/R 2525M 16



A-SVJBL/R 2020K 16



A-SVJBL/R 2525M 16

## **NEW** Threading



A-SEL/R 2020K 16



A-SEL/R 2525M 22



# Tornitura Interna A...MTFNR/L 16

Utensili per Tornitura Interna / Internal Turning Tools



**Compra 1 Utensile  
Buy 1 Toolholders**  
**10 INSERTI GRATIS  
FREE INSERTS**

CT9325



PT8430 **NEW**



Composizione Set / Set Composition

Cod. PROMO	n° 1 Utensile / Tool	n° 10 Inserti / Inserts		Prezzo / Price
PRM01-0029	A25R MTFNR 16	TNMG160404CM CT9325	●	€ 139,00
PRM01-0030	A32S MTFNR 16	TNMG160404CM CT9325	●	€ 149,00
PRM01-0031	A25R MTFNL 16	TNMG160404CM CT9325	●	€ 139,00
PRM01-0032	A32S MTFNL 16	TNMG160404CM CT9325	●	€ 149,00
PRM01-0033	A25R MTFNR 16	TNMG160408CMR PT8430	●	€ 139,00
PRM01-0034	A32S MTFNR 16	TNMG160408CMR PT8430	●	€ 149,00
PRM01-0035	A25R MTFNL 16	TNMG160408CMR PT8430	●	€ 139,00
PRM01-0036	A32S MTFNL 16	TNMG160408CMR PT8430	●	€ 149,00

# Tornitura Interna A...PCLNR/L 12

Utensili per Tornitura Interna / Internal Turning Tools



**Compra 1 Utensile  
Buy 1 Toolholders**  
**10 INSERTI GRATIS  
FREE INSERTS**

CT9325



PT8430 **NEW**



Composizione Set / Set Composition

Cod. PROMO	n° 1 Utensile / Tool	n° 10 Inserti / Inserts		Prezzo / Price
PRM01-0037	A25R PCLNR 12	CNMG120408CMR CT9325	●	€ 139,00
PRM01-0038	A32S PCLNR 12	CNMG120408CMR CT9325	●	€ 149,00
PRM01-0039	A25R PCLNL 12	CNMG120408CMR CT9325	●	€ 139,00
PRM01-0040	A32S PCLNL 12	CNMG120408CMR CT9325	●	€ 149,00
PRM01-0041	A25R PCLNR 12	CNMG120408CMR PT8430	●	€ 139,00
PRM01-0042	A32S PCLNR 12	CNMG120408CMR PT8430	●	€ 149,00
PRM01-0043	A25R PCLNL 12	CNMG120408CMR PT8430	●	€ 139,00
PRM01-0044	A32S PCLNL 12	CNMG120408CMR PT8430	●	€ 149,00

# Tornitura Interna A...SCLCR/L 09

Utensili per Tornitura Interna / Internal Turning Tools



**Compra 1 Utensile  
Buy 1 Toolholders**  
**10 INSERTI GRATIS  
FREE INSERTS**

CT9325



PT8430 **NEW**



## Composizione Set / Set Composition

Cod. PROMO	n° 1 Utensile / Tool	n° 10 Inserti / Inserts	Prezzo / Price
PRM01-0045	A16M SCLCR 09	CCMT09T304CSF CT9325 ●	€ 119,00
PRM01-0046	A20Q SCLCR 09	CCMT09T304CSF CT9325 ●	€ 129,00
PRM01-0047	A25R SCLCR 09	CCMT09T304CSF CT9325 ●	€ 139,00
PRM01-0048	A16M SCLCL 09	CCMT09T304CSF CT9325 ●	€ 119,00
PRM01-0049	A20Q SCLCL 09	CCMT09T304CSF CT9325 ●	€ 129,00
PRM01-0050	A25R SCLCL 09	CCMT09T304CSF CT9325 ●	€ 139,00
PRM01-0051	A16M SCLCR 09	CCMT09T308CSM PT8430 ●	€ 119,00
PRM01-0052	A20Q SCLCR 09	CCMT09T308CSM PT8430 ●	€ 129,00
PRM01-0053	A25R SCLCR 09	CCMT09T308CSM PT8430 ●	€ 139,00
PRM01-0054	A16M SCLCL 09	CCMT09T308CSM PT8430 ●	€ 119,00
PRM01-0055	A20Q SCLCL 09	CCMT09T308CSM PT8430 ●	€ 129,00
PRM01-0056	A25R SCLCL 09	CCMT09T308CSM PT8430 ●	€ 139,00

# Tornitura Interna A...SDUCR/L 11

Utensili per Tornitura Interna / Internal Turning Tools



**Compra 1 Utensile  
Buy 1 Toolholders**  
**10 INSERTI GRATIS  
FREE INSERTS**

CT9325

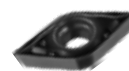

PT8430 **NEW**



## Composizione Set / Set Composition

Cod. PROMO	n° 1 Utensile / Tool	n° 10 Inserti / Inserts	Prezzo / Price
PRM01-0057	A20Q SDUCR 11	DCMT11T304CSF CT9325 ●	€ 139,00
PRM01-0058	A25R SDUCR 11	DCMT11T304CSF CT9325 ●	€ 149,00
PRM01-0059	A32S SDUCR 11	DCMT11T304CSF CT9325 ●	€ 159,00
PRM01-0060	A20Q SDUCL 11	DCMT11T304CSF CT9325 ●	€ 139,00
PRM01-0061	A25R SDUCL 11	DCMT11T304CSF CT9325 ●	€ 149,00
PRM01-0062	A32S SDUCL 11	DCMT11T304CSF CT9325 ●	€ 159,00
PRM01-0063	A20Q SDUCR 11	DCMT11T308CSM PT8430 ●	€ 139,00
PRM01-0064	A25R SDUCR 11	DCMT11T308CSM PT8430 ●	€ 149,00
PRM01-0065	A32S SDUCR 11	DCMT11T308CSM PT8430 ●	€ 159,00
PRM01-0066	A20Q SDUCL 11	DCMT11T308CSM PT8430 ●	€ 139,00
PRM01-0067	A25R SDUCL 11	DCMT11T308CSM PT8430 ●	€ 149,00
PRM01-0068	A32S SDUCL 11	DCMT11T308CSM PT8430 ●	€ 159,00

# Tornitura Interna

Set Utensili per Tornitura Interna / Internal Turning Tools Set



**NEW**  
CCMT0602  
PT8430



P M K S  
■ ■ ■ ■

**Compra 1 Set Utensili  
Buy 1 Tools Set**  
**10 INSERTI GRATIS  
FREE INSERTS**

**AcquaStream**  
by COMAND TOOL



**NEW**  
DCMT0702  
PT8430



P M K S  
■ ■ ■ ■

Composizione Set / Set Composition

Cod. PROMO	Cod. Set	Utensili / Tools	n° 10 Inserti / Inserts	Prezzo / Price
<b>PRM01-0069</b>	SETACL0816R	A0608H SCLCR 06	CCMT0602.. PT8430	<b>€ 169,00</b>
		A0810J SCLCR 06		
		A1012K SCLCR 06		
		A1216M SCLCR 06		
<b>PRM01-0070</b>	SETACL0816L	A0608H SCLCL 06	CCMT0602.. PT8430	<b>€ 169,00</b>
		A0810J SCLCL 06		
		A1012K SCLCL 06		
		A1216M SCLCL 06		
<b>PRM01-0071</b>	SETADU1016R	A0810J SDUCR 07	DCMT0702.. PT8430	<b>€ 159,00</b>
		A1012K SDUCR 07		
		A1216M SDUCR 07		
<b>PRM01-0072</b>	SETADU1016L	A0810J SDUCL 07	DCMT0702.. PT8430	<b>€ 159,00</b>
		A1012K SDUCL 07		
		A1216M SDUCL 07		



# Filettatura Esterna

External Threading



Compra 1 Utensile  
Buy 1 Toolholders  
**10 INSERTI GRATIS**  
FREE INSERTS

PT4320



P M N S  
■ ■ ■ □

Composizione Set / Set Composition

Cod. PROMO	n° 1 Utensile / Tool	n° 10 (5x2) Inserti / Inserts	Prezzo / Price
PRM01-0105	SER 2020K 16	16ER/IR P1,00 PT4320 ●	€ 149,00
PRM01-0106	SER 2525M 16	16ER/IR P1,25 PT4320 ●	€ 159,00
PRM01-0107	SEL 2020K 16	16ER/IR P1,50 PT4320 ●	€ 149,00
PRM01-0108	SEL 2525M 16	16ER/IR P2,00 PT4320 ●	€ 159,00

\* per gli utensili di Filettatura Esterna DESTRI utilizzare inserto 16ER..  
per gli utensili di Filettatura Esterna SINISTRI utilizzare inserto 16IR..

# Filettatura Interna

Internal Threading



AcquaStream  
by COMAND TOOL

Compra 1 Utensile  
Buy 1 Toolholders  
**10 INSERTI GRATIS**  
FREE INSERTS

PT4320



P M N S  
■ ■ ■ □

Composizione Set / Set Composition

Cod. PROMO	n° 1 Utensile / Tool	n° 10 (5x2) Inserti / Inserts	Prezzo / Price
PRM01-0109	A16M SIR 16	16IR/ER P1,00 PT4320 ●	€ 179,00
PRM01-0110	A20Q SIR 16	16IR/ER P1,25 PT4320 ●	€ 189,00
PRM01-0111	A16M SIL 16	16IR/ER P1,50 PT4320 ●	€ 179,00
PRM01-0112	A20Q SIL 16	16IR/ER P2,00 PT4320 ●	€ 189,00

NEW



AcquaStream  
by COMAND TOOL

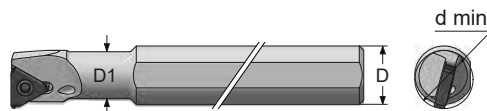

Compra 1 Utensile  
Buy 1 Toolholders  
**10 INSERTI GRATIS**  
FREE INSERTS

PT4320



P M N S  
■ ■ ■ □

Composizione Set / Set Composition

Cod. PROMO	n° 1 Utensile / Tool	n° 10 (5x2) Inserti / Inserts	D1	D	d min	Prezzo / Price
PRM01-0113	A1320Q SIR 16	16IR P1,00 PT4320 ●	13	20	17	€ 179,00
PRM01-0114	A1620Q SIR 16	16IR P1,25 PT4320 ●	16	20	20	€ 179,00
PRM01-0115	A2532S SIR 16	16IR P1,50 PT4320 ●	25	32	29	€ 199,00
		16IR P2,00 PT4320 ●				

\* per gli utensili di Filettatura Interna DESTRI utilizzare inserto 16IR..  
per gli utensili di Filettatura Interna SINISTRI utilizzare inserto 16ER..

# Frese per Spallamenti

Frese per Spallamenti a 90° / Shoulder Milling Cutters at 90°

Compra 1 Fresa  
Buy 1 Mill

**10** INSERTI GRATIS  
**FREE INSERTS**



**AquaStream**  
by COMAND TOOL



## Composizione Set / Set Composition

Cod. PROMO	Utensile / Tool	n° 10 Inserti / Inserts	Prezzo / Price
PRM02-0001	M30D16	APKT1003PDSR CM9325	€ 139,00
PRM02-0002	M30D20	APKT1003PDSR CM9325	€ 149,00
PRM02-0003	M30D25	APKT1003PDSR CM9325	€ 169,00
PRM02-0004	M32D40	APKT1003PDSR CM9325	€ 199,00
PRM02-0005	M32D50	APKT1003PDSR CM9325	€ 219,00
PRM02-0006	M35D16	APKT1003PDSR CM9325	€ 149,00
PRM02-0007	M35D20	APKT1003PDSR CM9325	€ 159,00
PRM02-0008	M35D25	APKT1003PDSR CM9325	€ 179,00
PRM02-0009	M50D25	APKT1604PDSR CM9325	€ 149,00
PRM02-0010	M50D32	APKT1604PDSR CM9325	€ 159,00
PRM02-0011	M52D40	APKT1604PDSR CM9325	€ 169,00
PRM02-0012	M52D50	APKT1604PDSR CM9325	€ 179,00
PRM02-0013	M52D63	APKT1604PDSR CM9325	€ 189,00
PRM02-0014	M52D80	APKT1604PDSR CM9325	€ 199,00
PRM02-0015	M55D25	APKT1604PDSR CM9325	€ 159,00
PRM02-0016	M55D32	APKT1604PDSR CM9325	€ 179,00





# Frese per Spallamenti

Frese per Spallamenti a 90° / Shoulder Milling Cutters at 90°

Compra 1 Fresa  
Buy 1 Mill

**10** INSERTI GRATIS  
FREE INSERTS

**INSERTI / INSERTS  
TPKT10**

## VANTAGGI / ADVANTAGES

- 3 taglienti elicoidali
- Spoglia assiale super-positiva
- Massima stabilità dell'inserto in fase di lavorazione
- 3 helical cutting edges
- Super-positive axial threshold
- Maximum insert stability during machining

**TPKT10**  
spallamento  
retto 90°

TPKT10



PM4325



TPKT10



PM2240



**AcquaStream**  
by COMAND TOOL

## Composizione Set / Set Composition

Cod. PROMO	Utensile / Tool	n° 10 Inserti / Inserts	Prezzo / Price
PRM02-0064	M332D40-5	TPKT100408 PM4325 ●	€ 209,00
PRM02-0065	M332D50-6	TPKT100408 PM4325 ●	€ 229,00
PRM02-0066	M332D40-5	TPKT100408 PM2240 ●	€ 209,00
PRM02-0067	M332D50-6	TPKT100408 PM2240 ●	€ 229,00
PRM02-0068	M330D20-2	TPKT100408 PM4325 ●	€ 179,00
PRM02-0069	M330D25-3	TPKT100408 PM4325 ●	€ 189,00
PRM02-0070	M330D32-4	TPKT100408 PM4325 ●	€ 199,00
PRM02-0071	M330D20-2	TPKT100408 PM2240 ●	€ 179,00
PRM02-0072	M330D25-3	TPKT100408 PM2240 ●	€ 189,00
PRM02-0073	M330D32-4	TPKT100408 PM2240 ●	€ 199,00

# Frese per Spallamenti

Frese per Spallamenti a 90° / Shoulder Milling Cutters at 90°

Compra 1 Fresa  
Buy 1 Mill

**10** INSERTI GRATIS  
FREE INSERTS

**INSERTI / INSERTS  
TPKT15**

## VANTAGGI / ADVANTAGES

- 3 taglienti elicoidali
- Spoglia assiale super-positiva
- Massima stabilità dell'inserto in fase di lavorazione
- 3 helical cutting edges
- Super-positive axial threshold
- Maximum insert stability during machining

**TPKT15**  
spallamento  
retto 90°

TPKT15



PM4325



TPKT15



PM2240



M342D...

**AcquaStream**  
by COMAND TOOL

## Composizione Set / Set Composition

Cod. PROMO	Utensile / Tool	n° 10 Inserti / Inserts	Prezzo / Price
PRM02-0074	M342D50-4	TPKT150508 PM4325 ●	€ 179,00
PRM02-0075	M342D50-5	TPKT150508 PM4325 ●	€ 189,00
PRM02-0076	M342D63-5	TPKT150508 PM4325 ●	€ 189,00
PRM02-0077	M342D63-6	TPKT150508 PM4325 ●	€ 199,00
PRM02-0078	M342D80-6	TPKT150508 PM4325 ●	€ 209,00
PRM02-0079	M342D80-8	TPKT150508 PM4325 ●	€ 229,00
PRM02-0080	M342D50-4	TPKT150508 PM2240 ●	€ 179,00
PRM02-0081	M342D50-5	TPKT150508 PM2240 ●	€ 189,00
PRM02-0082	M342D63-5	TPKT150508 PM2240 ●	€ 189,00
PRM02-0083	M342D63-6	TPKT150508 PM2240 ●	€ 199,00
PRM02-0084	M342D80-6	TPKT150508 PM2240 ●	€ 209,00
PRM02-0085	M342D80-8	TPKT150508 PM2240 ●	€ 229,00

# Frese per Motorizzati

Frese per Portautensile Motorizzati / Milling Cutters for Motorized Toolholders

**INSERTO / INSERT**  
**APKT0602..**

**Compra 1 Fresa**  
**Buy 1 Mill**

**10 INSERTI GRATIS**  
**FREE INSERTS**

**APKT0602**

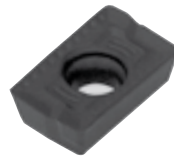

**PM4335**



esempio di Portautensile Motorizzato  
example of Motorized Toolholders

**AcquaStream**  
by COMAND TOOL



M300D10-2



M300D12-3



M300D16-4

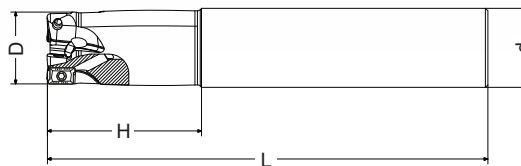

Composizione Set / Set Composition

Cod. PROMO	Utensile / Tool	D	d	Z	L	H	n° 10 Inserti / Inserts	Prezzo / Price
<b>PRM02-0086</b>	M300D10-2	10	10	2	72	16	APKT0602PDSR PM4335	<b>€ 139,00</b>
<b>PRM02-0087</b>	M300D12-3	12	12	3	80	26	APKT0602PDSR PM4335	<b>€ 149,00</b>
<b>PRM02-0088</b>	M300D16-4	16	16	4	90	32	APKT0602PDSR PM4335	<b>€ 159,00</b>

**KIT**

Composizione Set / Set Composition

Cod. PROMO	Utensili / Tools	n° 10 Inserti / Inserts	Prezzo / Price
<b>PRM02-0089</b>	M300D10-2 + M300D12-3 + M300D16-4	APKT0602PDSR PM4335	<b>€ 269,00</b>



**COMAND**  
TOOL

# Frese per Spianatura

Frese per Spianatura / Milling Cutters

Compra 1 Fresa  
Buy 1 Mill

**10** INSERTI GRATIS  
FREE INSERTS

SEKT13T3  
PM4325



SNEX1206  
PM4325



M132

AcquaStream  
by COMAND TOOL

M232

Composizione Set / Set Composition

Cod. PROMO	Utensile / Tool	n° 10 Inserti / Inserts	Prezzo / Price
PRM02-0043	M132D40	SEKT13T3AGSN PM4325	€ 209,00
PRM02-0044	M132D50	SEKT13T3AGSN PM4325	€ 219,00
PRM02-0045	M132D63	SEKT13T3AGSN PM4325	€ 229,00
PRM02-0046	M132D80	SEKT13T3AGSN PM4325	€ 239,00

Cod. PROMO	Utensile / Tool	n° 10 Inserti / Inserts	Prezzo / Price
PRM02-0051	M232D50	SNEX1206ANN PM4325	€ 239,00
PRM02-0052	M232D63	SNEX1206ANN PM4325	€ 259,00
PRM02-0053	M232D80	SNEX1206ANN PM4325	€ 269,00

# Frese per Cave a "T"

Frese Slot / Slot Mills



AcquaStream  
by COMAND TOOL

Compra 1 Utensile  
Buy 1 Toolholders  
**10** INSERTI GRATIS  
FREE INSERTS

XPMT...  
PM4325



Composizione Set / Set Composition

Cod. PROMO	n° 1 Utensile / Tool	n° 10 Inserti / Inserts	Prezzo / Price
PRM02-0056	SLOT-21-09	XPMT060304 PM4325	€ 239,00
PRM02-0057	SLOT-25-11	XPMT060304 PM4325	€ 259,00
PRM02-0058	SLOT-28-12	XPMT060304 PM4325	€ 269,00
PRM02-0059	SLOT-32-14	XPMT09T308 PM4325	€ 299,00
PRM02-0060	SLOT-36-16	XPMT09T308 PM4325	€ 309,00
PRM02-0061	SLOT-40-17	XPMT09T308 PM4325	€ 319,00
PRM02-0062	SLOT-45-20	XPMT120408 PM4325	€ 329,00
PRM02-0063	SLOT-50-22	XPMT120408 PM4325	€ 339,00

# Frese per Centrinatura

**NEW**

Frese per Centrinatura e Smussi / Milling Cutters for Centering and Chamfers

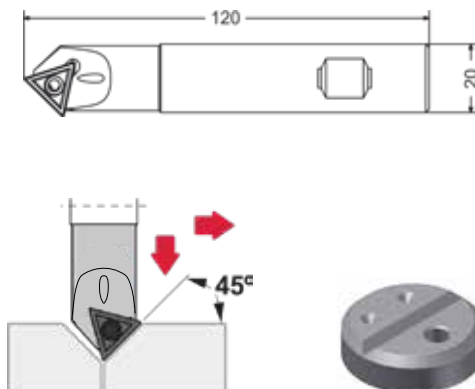

Compra 1 Fresa  
Buy 1 Mill

**5** INSERTI GRATIS  
FREE INSERTS

TXMX16T300  
PM4325

**NEW**



Frese adatte a svolgere lavorazioni di centrinatura, incisione, scanalatura e smussatura in fresatrici e centri di lavoro, ed anche per centrinatura e spianatura in torni CNC.

Composizione Set / Set Composition

Cod. PROMO	Utensile / Tool	n° 5 Inserti / Inserts	Prezzo / Price
<b>PRM02-0094</b>	SCT0020	TXMX16T300 PM4325	<b>€ 119,00</b>

# Frese Graduali

Frese per Smussare e Svasare con Angolo Regolabile / Chamfering and Flaring Milling Cutters with Adjustable Angle



Compra 1 Fresa  
Buy 1 Mill

**10** INSERTI GRATIS  
FREE INSERTS

TCMT110208  
TCMT16T308  
PT8430

**NEW**

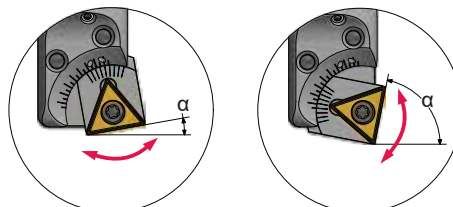

$\alpha$  = angolo regolabile / adjustable corner

movimento graduale da 5° a 95°  
gradual movement from 5° to 95°

Composizione Set / Set Composition

Cod. PROMO	Utensile / Tool	n° 10 Inserti / Inserts	Prezzo / Price
<b>PRM02-0054</b>	SRT0520-20	TCMT110208CSM PT8430	<b>€ 199,00</b>
<b>PRM02-0055</b>	SRT0523-25	TCMT16T308CSM PT8430	<b>€ 209,00</b>



# Frese per Smussi a Trazione 45°

45° back Chamfering Mills

AcquaStream  
by COMAND TOOL



Compra 1 Fresa  
Buy 1 Mill  
**10** INSERTI GRATIS  
FREE INSERTS

CCMT060204CSM  
CCMT09T308CSM

PT8430

NEW



P M K S  
■ ■ ■ ■

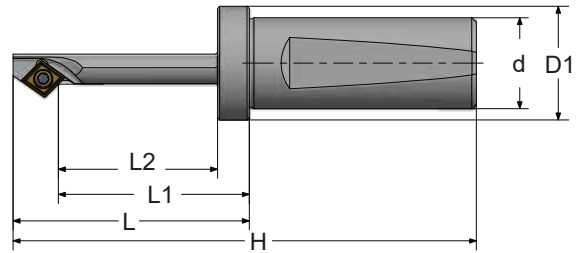
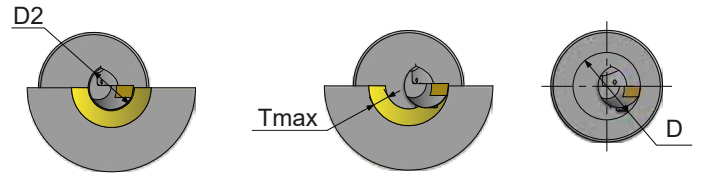

Set Composition

Cod. PROMO	Articolo / Item	Ins.	D	D2	D1	d	Tmax	E	H	L	L1	L2	Prezzo / Price
PRM03-0001	FB45D150-06	CC..06	15	10	25	20	2,5	2,8	100	50	42	35	€ 189,00
PRM03-0002	FB45D200-06	CC..06	20	14	25	20	3	3,2	105	55	47	40	€ 189,00
PRM03-0003	FB45D230-06	CC..06	23	17	25	20	3	3,2	115	65	57	50	€ 189,00
PRM03-0004	FB45D270-09	CC..09	27	21	25	20	3	3,4	138	88	77	70	€ 189,00
PRM03-0005	FB45D310-09	CC..09	31	24	25	20	3,5	3,9	148	98	87	80	€ 189,00

## Istruzioni per l'utilizzo Frese per Smussi a Trazione 45°

Instruction for use 45° back Chamfering Mills

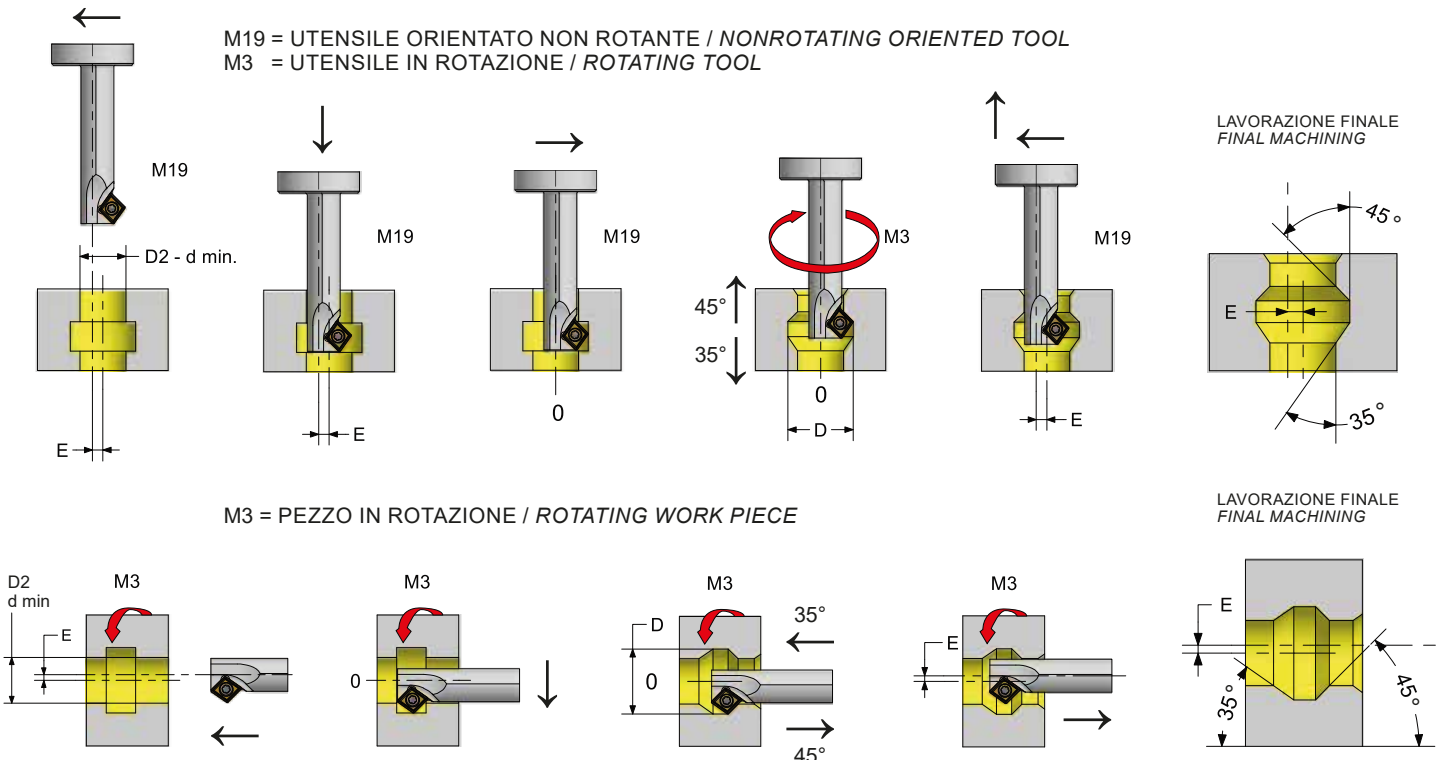

# Frese per Lamature a Trazione 90°

90° back Spot-Facing Mills

AcquaStream  
by COMAND TOOL



Compra 1 Fresa  
Buy 1 Mill  
**10** INSERTI GRATIS  
FREE INSERTS

CCMT060204CSM  
CCMT09T308CSM

PT8430

NEW



P M K S  
■ ■ ■ ■

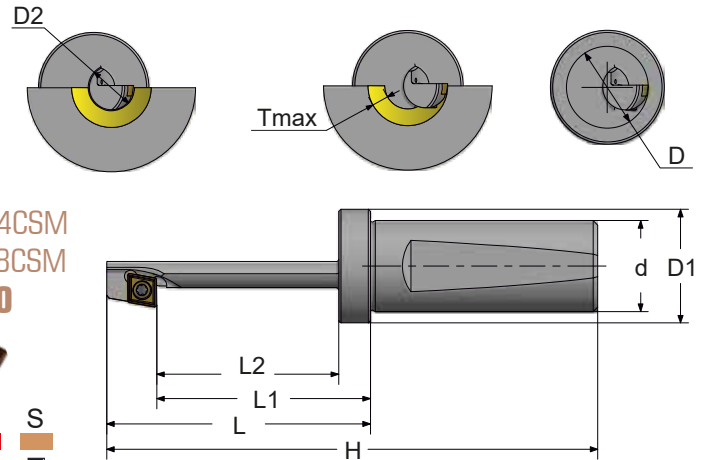

Set Composition

Cod. PROMO	Articolo / Item	Ins.	D	D2	D1	d	Tmax	E	H	L	L1	L2	Prezzo / Price
PRM03-0006	FB90D180-06	CC..06	18	10,5	25	20	3,75	4	108	58	47	40	€ 189,00
PRM03-0007	FB90D200-06	CC..06	20	13	25	20	3,5	3,75	113	63	52	45	€ 189,00
PRM03-0008	FB90D240-06	CC..06	24	15	25	20	4,5	4,75	118	68	57	50	€ 189,00
PRM03-0009	FB90D260-06	CC..06	26	17	25	20	4,5	5	128	78	67	60	€ 189,00
PRM03-0010	FB90D300-06	CC..06	30	19	25	20	5,5	6	133	83	72	65	€ 189,00
PRM03-0011	FB90D330-09	CC..09	33	21	25	20	6	6,6	148	98	82	75	€ 189,00



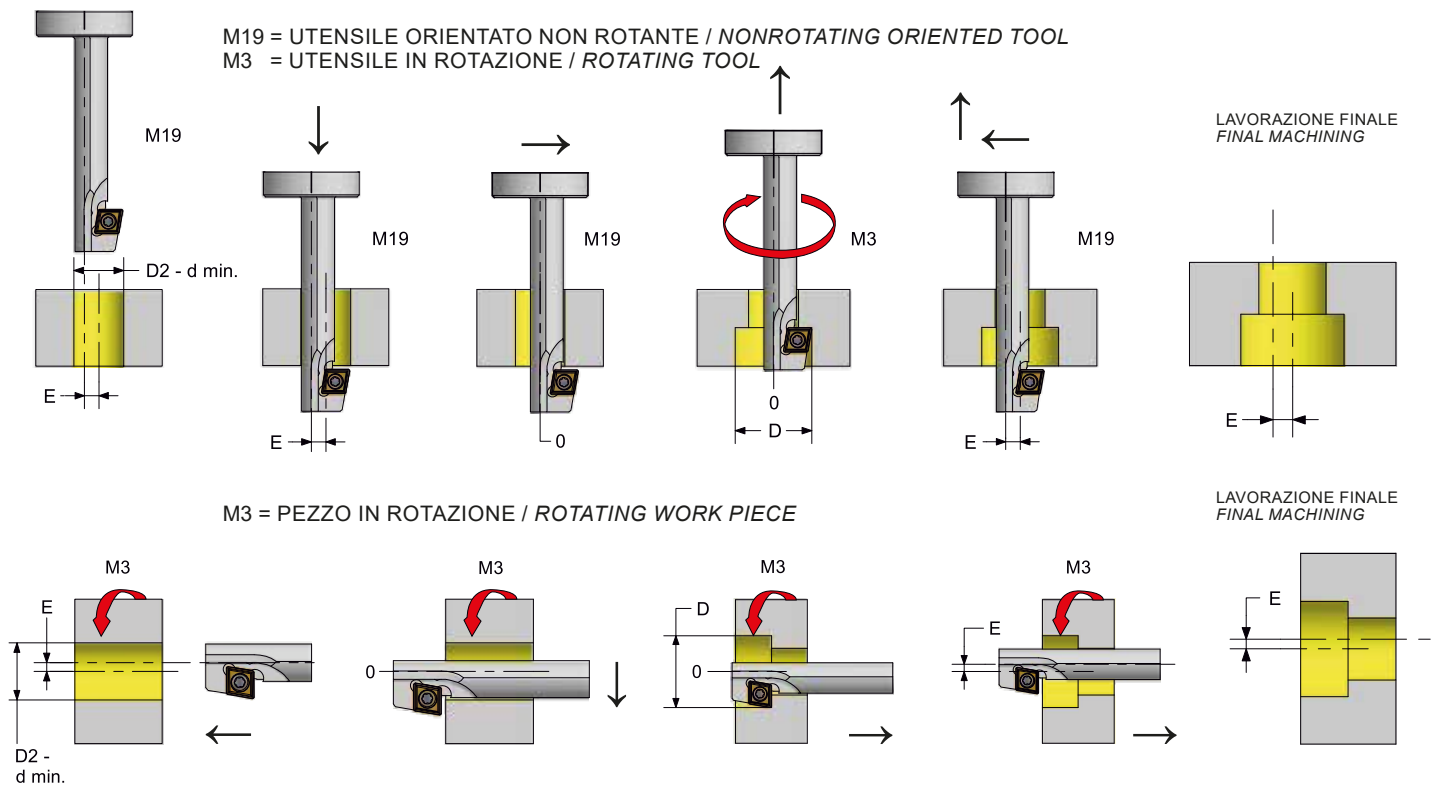

## Istruzioni per l'utilizzo Frese per Lamatura a Trazione 90°

Instruction for use 90° back Spot-Facing Mills



# Inserti Fresatura

Milling Inserts

Inserti / Inserts	Codice Inserto / Insert Code	Prezzo per singolo Inserto / Single Insert price	
		Ordine minimo / Minimum order n° 50 pz	Ordine minimo / Minimum order n° 100 pz
	TPKT100408 PM4325	€ 8,10	€ 7,70
	TPKT100408 PM2240	€ 8,10	€ 7,70
	TPKT150508 PM4325	€ 8,70	€ 8,10
	TPKT150508 PM2240	€ 8,70	€ 8,10
	APKT0602PDSR PM4325	€ 6,40	€ 5,90
	APKT1003PDSR PM8140	€ 5,40	€ 4,60
	APKT1003PDSR CM9325	€ 5,40	€ 4,60
	APKT1604PDSR CM9325	€ 5,90	€ 5,10
	APKT1604PDSR PM8140	€ 5,90	€ 5,10
	SEKT13T3AGSN PM4325	€ 7,10	€ 6,50
	SNMX1206ANN PM4325	€ 7,10	€ 6,50



# Punte per Foratura 3xD - LCKX05

Punte ad Inserto 3xD / Insert Indexable Drill 3xD



**Compra 1 Utensile  
Buy 1 Toolholders**  
**10 INSERTI GRATIS  
FREE INSERTS**

LCKX05  
PD4135



P M K S  
■ ■ ■ ■

## Composizione Set / Set Composition

Cod. PROMO	Diametro / Diameter	n° 1 Utensile / Tool	n° 10 Inserti / Inserts	Prezzo / Price
PRM07-0001	Ø 12,0	FD03D120	LCKX05 PD4135	€ 169,00
PRM07-0002	Ø 12,5	FD03D125	LCKX05 PD4135	€ 169,00
PRM07-0003	Ø 13,0	FD03D130	LCKX05 PD4135	€ 169,00
PRM07-0004	Ø 13,5	FD03D135	LCKX05 PD4135	€ 169,00
PRM07-0005	Ø 14,0	FD03D140	LCKX05 PD4135	€ 169,00
PRM07-0006	Ø 14,5	FD03D145	LCKX05 PD4135	€ 169,00
PRM07-0007	Ø 15,0	FD03D150	LCKX05 PD4135	€ 169,00
PRM07-0008	Ø 15,5	FD03D155	LCKX05 PD4135	€ 169,00
PRM07-0009	Ø 16,0	FD03D160	LCKX05 PD4135	€ 169,00
PRM07-0010	Ø 16,5	FD03D165	LCKX05 PD4135	€ 169,00
PRM07-0011	Ø 17,0	FD03D170	LCKX05 PD4135	€ 169,00

# Punte per Foratura 3xD - LCKX07

Punte ad Inserto 3xD / Insert Indexable Drill 3xD

LCKX07  
PD4135



PRM07-0012	Ø 17,5	FD03D175	LCKX07 PD4135	€ 179,00
PRM07-0013	Ø 18,0	FD03D180	LCKX07 PD4135	€ 179,00
PRM07-0014	Ø 18,5	FD03D185	LCKX07 PD4135	€ 179,00
PRM07-0015	Ø 19,0	FD03D190	LCKX07 PD4135	€ 179,00
PRM07-0016	Ø 19,5	FD03D195	LCKX07 PD4135	€ 179,00
PRM07-0017	Ø 20,0	FD03D200	LCKX07 PD4135	€ 179,00
PRM07-0018	Ø 20,5	FD03D205	LCKX07 PD4135	€ 179,00
PRM07-0019	Ø 21,0	FD03D210	LCKX07 PD4135	€ 179,00
PRM07-0020	Ø 21,5	FD03D215	LCKX07 PD4135	€ 179,00
PRM07-0021	Ø 22,0	FD03D220	LCKX07 PD4135	€ 179,00
PRM07-0022	Ø 22,5	FD03D225	LCKX07 PD4135	€ 179,00
PRM07-0023	Ø 23,0	FD03D230	LCKX07 PD4135	€ 179,00
PRM07-0024	Ø 23,5	FD03D235	LCKX07 PD4135	€ 179,00
PRM07-0025	Ø 24,0	FD03D240	LCKX07 PD4135	€ 179,00
PRM07-0026	Ø 24,5	FD03D245	LCKX07 PD4135	€ 179,00
PRM07-0027	Ø 25,0	FD03D250	LCKX07 PD4135	€ 179,00
PRM07-0028	Ø 25,5	FD03D255	LCKX07 PD4135	€ 179,00
PRM07-0029	Ø 26,0	FD03D260	LCKX07 PD4135	€ 179,00

# Punte per Foratura 3xD - WCMX05/06/08

Punte ad Inserto 3xD / Insert Indexable Drill 3xD



AcquaStream  
by COMAND TOOL

Compra 1 Utensile  
Buy 1 Toolholders  
**10** INSERTI GRATIS  
FREE INSERTS

WCMX...  
CT4125



P M K S  
■ ■ ■ ■

## Composizione Set / Set Composition

Cod. PROMO	Diametro / Diameter	n° 1 Utensile / Tool	n° 10 Inserti / Inserts	Prezzo / Price
PRM07-0030	Ø 27,0	FD03D270	WCMX05 CT4125	€ 229,00
PRM07-0031	Ø 28,0	FD03D280	WCMX05 CT4125	€ 229,00
PRM07-0032	Ø 29,0	FD03D290	WCMX05 CT4125	€ 229,00
PRM07-0033	Ø 30,0	FD03D300	WCMX05 CT4125	€ 229,00
PRM07-0034	Ø 31,0	FD03D310	WCMX05 CT4125	€ 229,00
PRM07-0035	Ø 32,0	FD03D320	WCMX06 CT4125	€ 249,00
PRM07-0036	Ø 33,0	FD03D330	WCMX06 CT4125	€ 249,00
PRM07-0037	Ø 34,0	FD03D340	WCMX06 CT4125	€ 249,00
PRM07-0038	Ø 35,0	FD03D350	WCMX06 CT4125	€ 249,00
PRM07-0039	Ø 36,0	FD03D360	WCMX06 CT4125	€ 249,00
PRM07-0040	Ø 37,0	FD03D370	WCMX06 CT4125	€ 249,00
PRM07-0041	Ø 38,0	FD03D380	WCMX06 CT4125	€ 249,00
PRM07-0042	Ø 39,0	FD03D390	WCMX06 CT4125	€ 249,00
PRM07-0043	Ø 40,0	FD03D400	WCMX06 CT4125	€ 249,00
PRM07-0044	Ø 41,0	FD03D410	WCMX08 CT4125	€ 269,00
PRM07-0045	Ø 42,0	FD03D420	WCMX08 CT4125	€ 269,00
PRM07-0046	Ø 43,0	FD03D430	WCMX08 CT4125	€ 269,00
PRM07-0047	Ø 44,0	FD03D440	WCMX08 CT4125	€ 269,00
PRM07-0048	Ø 45,0	FD03D450	WCMX08 CT4125	€ 269,00
PRM07-0049	Ø 46,0	FD03D460	WCMX08 CT4125	€ 269,00
PRM07-0050	Ø 47,0	FD03D470	WCMX08 CT4125	€ 269,00
PRM07-0051	Ø 48,0	FD03D480	WCMX08 CT4125	€ 269,00
PRM07-0052	Ø 49,0	FD03D490	WCMX08 CT4125	€ 269,00
PRM07-0053	Ø 50,0	FD03D500	WCMX08 CT4125	€ 269,00
PRM07-0054	Ø 51,0	FD03D510	WCMX08 CT4125	€ 269,00
PRM07-0055	Ø 52,0	FD03D520	WCMX08 CT4125	€ 269,00
PRM07-0056	Ø 53,0	FD03D530	WCMX08 CT4125	€ 269,00
PRM07-0057	Ø 54,0	FD03D540	WCMX08 CT4125	€ 269,00
PRM07-0058	Ø 55,0	FD03D550	WCMX08 CT4125	€ 269,00
PRM07-0059	Ø 56,0	FD03D560	WCMX08 CT4125	€ 269,00
PRM07-0060	Ø 57,0	FD03D570	WCMX08 CT4125	€ 269,00
PRM07-0061	Ø 58,0	FD03D580	WCMX08 CT4125	€ 269,00



# Punte per Foratura 4xD - LCKX05

Punte ad Inserto 4xD / Insert Indexable Drill 4xD



**AcquaStream**  
by COMAND TOOL

**Compra 1 Utensile  
Buy 1 Toolholders**  
**10 INSERTI GRATIS  
FREE INSERTS**

LCKX05  
PD4325



P M K S  
■ ■ ■ ■

Composizione Set / Set Composition

Cod. PROMO	Diametro / Diameter	n° 1 Utensile / Tool	n° 10 Inserti / Inserts	Prezzo / Price
PRM07-0062	Ø 13,0	FD04D130	LCKX05 PD4325	€ 199,00
PRM07-0063	Ø 13,5	FD04D135	LCKX05 PD4325	€ 199,00
PRM07-0064	Ø 14,0	FD04D140	LCKX05 PD4325	€ 199,00
PRM07-0065	Ø 14,5	FD04D145	LCKX05 PD4325	€ 199,00
PRM07-0066	Ø 15,0	FD04D150	LCKX05 PD4325	€ 199,00
PRM07-0067	Ø 15,5	FD04D155	LCKX05 PD4325	€ 199,00
PRM07-0068	Ø 16,0	FD04D160	LCKX05 PD4325	€ 199,00
PRM07-0069	Ø 16,5	FD04D165	LCKX05 PD4325	€ 199,00
PRM07-0070	Ø 17,0	FD04D170	LCKX05 PD4325	€ 199,00

# Punte per Foratura 4xD - LCKX07

Punte ad Inserto 4xD / Insert Indexable Drill 4xD



**AcquaStream**  
by COMAND TOOL

**Compra 1 Utensile  
Buy 1 Toolholders**  
**10 INSERTI GRATIS  
FREE INSERTS**

LCKX07  
PD4325



P M K S  
■ ■ ■ ■

Composizione Set / Set Composition

Cod. PROMO	Diametro / Diameter	n° 1 Utensile / Tool	n° 10 Inserti / Inserts	Prezzo / Price
PRM07-0071	Ø 17,5	FD04D175	LCKX07 PD4325	€ 209,00
PRM07-0072	Ø 18,0	FD04D180	LCKX07 PD4325	€ 209,00
PRM07-0073	Ø 18,5	FD04D185	LCKX07 PD4325	€ 209,00
PRM07-0074	Ø 19,0	FD04D190	LCKX07 PD4325	€ 209,00
PRM07-0075	Ø 19,5	FD04D195	LCKX07 PD4325	€ 209,00
PRM07-0076	Ø 20,0	FD04D200	LCKX07 PD4325	€ 209,00
PRM07-0077	Ø 21,0	FD04D210	LCKX07 PD4325	€ 209,00
PRM07-0078	Ø 22,0	FD04D220	LCKX07 PD4325	€ 209,00
PRM07-0079	Ø 23,0	FD04D230	LCKX07 PD4325	€ 209,00
PRM07-0080	Ø 24,0	FD04D240	LCKX07 PD4325	€ 209,00
PRM07-0081	Ø 25,0	FD04D250	LCKX07 PD4325	€ 209,00

# Punte per Foratura 4xD - LCKX11

Punte ad Inserto 4xD / Insert Indexable Drill 4xD



AcquaStream  
by COMAND TOOL

Compra 1 Utensile  
Buy 1 Toolholders  
**10** INSERTI GRATIS  
FREE INSERTS

LCKX11  
PD4325

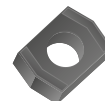

## Composizione Set / Set Composition

Cod. PROMO	Diametro / Diameter	n° 1 Utensile / Tool	n° 10 Inserti / Inserts	Prezzo / Price
PRM07-0082	Ø 26,0	FD04D260-LC	LCKX11 PD4325	€ 239,00
PRM07-0083	Ø 27,0	FD04D270-LC	LCKX11 PD4325	€ 239,00
PRM07-0084	Ø 28,0	FD04D280-LC	LCKX11 PD4325	€ 239,00
PRM07-0085	Ø 29,0	FD04D290-LC	LCKX11 PD4325	€ 239,00
PRM07-0086	Ø 30,0	FD04D300-LC	LCKX11 PD4325	€ 239,00
PRM07-0087	Ø 31,0	FD04D310-LC	LCKX11 PD4325	€ 239,00
PRM07-0088	Ø 32,0	FD04D320-LC	LCKX11 PD4325	€ 239,00
PRM07-0089	Ø 33,0	FD04D330-LC	LCKX11 PD4325	€ 239,00
PRM07-0090	Ø 34,0	FD04D340-LC	LCKX11 PD4325	€ 239,00
PRM07-0091	Ø 35,0	FD04D350-LC	LCKX11 PD4325	€ 239,00
PRM07-0092	Ø 36,0	FD04D360-LC	LCKX11 PD4325	€ 239,00
PRM07-0093	Ø 37,0	FD04D370-LC	LCKX11 PD4325	€ 239,00
PRM07-0094	Ø 38,0	FD04D380-LC	LCKX11 PD4325	€ 239,00
PRM07-0095	Ø 39,0	FD04D390-LC	LCKX11 PD4325	€ 239,00
PRM07-0096	Ø 40,0	FD04D400-LC	LCKX11 PD4325	€ 239,00

# Lamatori SB825

Set Frese per Lamatura / Spot Facing Boring Bar

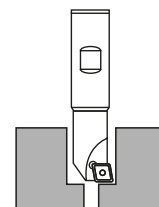

## Composizione Set / Set Composition

Cod. PROMO	Articolo / Item	n° 8 Utensili / Tools	NO Inserti / Inserts	Prezzo / Price
PRM07-0097	SET-SB825	SB08M04 - SB09M05 - SB11M06 - SB14-M08 SB17M10 - SB19M12 - SB22M14 - SB25-M16	-	€ 319,00
Cod. PROMO	Articolo / Item	n° 8 Utensili / Tools	n° 30 Inserti / Inserts	Prezzo / Price
PRM07-0098	SET-SB825-i	SB08M04 - SB09M05 - SB11M06 - SB14-M08 SB17M10 - SB19M12 - SB22M14 - SB25-M16	EP05.. (10 pz) EC06.. (10 pz) EC08.. (10 pz)	€ 459,00

\* il set include 2 Chiavi Torx / set includes 2 Torx Key (CTX06 - CTX08)



# R.D.S. Radial Drilling Setter

**DIAMETRO REGOLABILE**  
**ADJUSTABLE DIAMETER**

Mandrino per Foratura Multidiametro / Holder for Multidiameter Drilling



DIN 69871



MAS 403 BT



HSK63 DIN69893



DIN ISO 26623-1

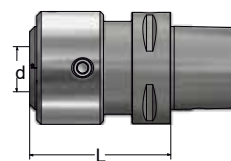
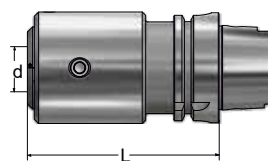
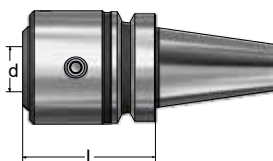
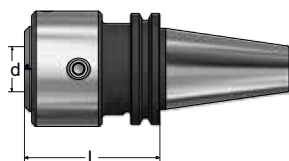

Tutti gli R.D.S. sono provvisti di **AcquaStream** / All R.D.S. are provided with **AcquaStream**

## Composizione Set / Set Composition

Cod. PROMO	Articolo / Item	Tipo Cono / Cone Type	d	L	Q.tà / Q.ty	Prezzo / Price
<b>PRM04-0001</b>	RDS K40-20 075	ISO 40 DIN 69871	20	75	1	€ 340,00
<b>PRM04-0002</b>	RDS K40-25 075	ISO 40 DIN 69871	25	75	1	€ 340,00
<b>PRM04-0003</b>	RDS K40-32 100	ISO 40 DIN 69871	32	100	1	€ 340,00
<b>PRM04-0013</b>	RDS K50-20 075	ISO 50 DIN 69871	20	75	1	€ 370,00
<b>PRM04-0014</b>	RDS K50-25 075	ISO 50 DIN 69871	25	75	1	€ 370,00
<b>PRM04-0004</b>	RDS K50-32 075	ISO 50 DIN 69871	32	75	1	€ 370,00
<b>PRM04-0005</b>	RDS B40-20 075	MAS 403 BT40	20	75	1	€ 340,00
<b>PRM04-0006</b>	RDS B40-25 075	MAS 403 BT40	25	75	1	€ 340,00
<b>PRM04-0007</b>	RDS B40-32 100	MAS 403 BT40	32	100	1	€ 340,00
<b>PRM04-0015</b>	RDS B50-20 075	MAS 403 BT50	20	75	1	€ 370,00
<b>PRM04-0016</b>	RDS B50-25 075	MAS 403 BT50	25	75	1	€ 370,00
<b>PRM04-0008</b>	RDS B50-32 075	MAS 403 BT50	32	75	1	€ 370,00
<b>PRM04-0009</b>	RDS H63-20 105	HSK63 DIN69893 A	20	105	1	€ 350,00
<b>PRM04-0010</b>	RDS H63-25 105	HSK63 DIN69893 A	25	105	1	€ 350,00
<b>PRM04-0017</b>	RDS H63-32 120	HSK63 DIN69893 A	32	120	1	€ 350,00
<b>PRM04-0011</b>	RDS C06-20 080	DIN ISO 26623-1 (C06)	20	80	1	€ 360,00
<b>PRM04-0012</b>	RDS C06-25 080	DIN ISO 26623-1 (C06)	25	80	1	€ 360,00
<b>PRM04-0018</b>	RDS C06-32 090	DIN ISO 26623-1 (C06)	32	90	1	€ 360,00

## Fissaggio corretto della Punta su R.D.S.

Correct drill fixing on R.D.S.

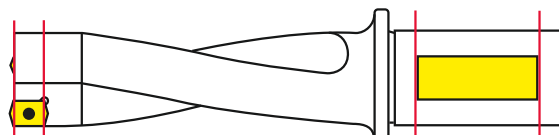

Il piano dell'attacco della punta per il fissaggio deve sempre essere parallelo alla sede dell'inserto esterno.  
The milled surface on the drill shank must be parallel to the external insert pocket.

# Pinze Cono Morse

Pinze Cono Morse per Mandrini / Morse Taper Collets

**PROMO**

**3**  
pz / PCS

Ordine minimo  
Minimum order

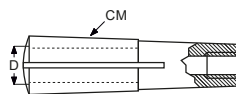

Cod. PROMO	PREZZO / PRICE Singola Pinza / Single Collet
<b>PRM06-0001</b>	<b>€ 16,00</b>



Articolo / Item	D	CM
PNZ-01D02	2	1
PNZ-01D03	3	1
PNZ-01D04	4	1
PNZ-01D05	5	1
PNZ-01D06	6	1
PNZ-01D08	8	1
PNZ-02D03	3	2
PNZ-02D04	4	2
PNZ-02D05	5	2
PNZ-02D06	6	2
PNZ-02D08	8	2
PNZ-02D10	10	2
PNZ-02D12	12	2
PNZ-02D035	3,5	2
PNZ-02D045	4,5	2
PNZ-02D07	7	2
PNZ-02D09	9	2

**PROMO**

**5**  
pz / PCS

Ordine minimo  
Minimum order

Cod. PROMO	PREZZO / PRICE Singola Pinza / Single Collet
<b>PRM06-0002</b>	<b>€ 14,00</b>



# Mandrini MABT40 PC2

# BT40 MAS 403

Mandrino Portapinza di Precisione / Precision Collet Holder

**SET**

**SOLO  
MANDRINI  
CHUCKS ONLY**

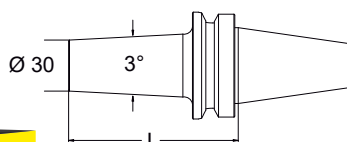

AcquaStream



**KIT**

**1 MANDRINO  
+  
7 PINZE  
1 CHUCK + 7 COLLETS**



Composizione Set / Set Composition

Cod. PROMO	Articolo / Item	L	Q.ty	Prezzo / Price
<b>PRM06-0035</b>	MABT40 PC2 070	70	3 pz	<b>€ 290,00</b>
<b>PRM06-0036</b>	MABT40 PC2 100	100	3 pz	<b>€ 300,00</b>
<b>PRM06-0037</b>	MABT40 PC2 130	130	3 pz	<b>€ 310,00</b>
<b>PRM06-0038</b>	MABT40 PC2 070	70	5 pz	<b>€ 420,00</b>
<b>PRM06-0039</b>	MABT40 PC2 100	100	5 pz	<b>€ 430,00</b>
<b>PRM06-0040</b>	MABT40 PC2 130	130	5 pz	<b>€ 440,00</b>
<b>PRM06-0041</b>	MABT40 PC2 070	70	10 pz	<b>€ 750,00</b>
<b>PRM06-0042</b>	MABT40 PC2 100	100	10 pz	<b>€ 760,00</b>
<b>PRM06-0043</b>	MABT40 PC2 130	130	10 pz	<b>€ 770,00</b>

Kit 1 MANDRINO / CHUCK + 7 PINZE / COLLET

n° 1 Mandrino BT

n° 7 Pinze Ø 3/4/5/6/8/10/12

n° 1 Chiave di bloccaggio

n° 1 Dado di estrazione

Cod. PROMO

Prezzo / Price

**PRM06-0044** (070)

**€ 145,00**

**PRM06-0045** (100)

**€ 145,00**

**PRM06-0046** (130)

**€ 145,00**

# Mandrini MASK40 PC1

ISO40 DIN 69871

Mandrino Portapinza di Precisione / Precision Collet Holder

**SET**

**SOLO  
MANDRINI  
CHUCKS ONLY**

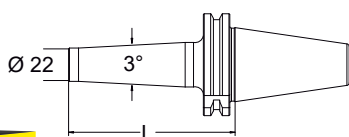

AcquaStream  
by COMAND TOOL



**KIT**

**1 MANDRINO  
+  
6 PINZE  
1 CHUCK + 6 COLLETS**



Composizione Set / Set Composition

Cod. PROMO	Articolo / Item	L	Q.ty	Prezzo / Price
PRM06-0047	MASK40 PC1 070	70	3 pz	€ 290,00
PRM06-0048	MASK40 PC1 100	100	3 pz	€ 300,00
PRM06-0049	MASK40 PC1 130	130	3 pz	€ 310,00
PRM06-0050	MASK40 PC1 070	70	5 pz	€ 420,00
PRM06-0051	MASK40 PC1 100	100	5 pz	€ 430,00
PRM06-0052	MASK40 PC1 130	130	5 pz	€ 440,00
PRM06-0053	MASK40 PC1 070	70	10 pz	€ 750,00
PRM06-0054	MASK40 PC1 100	100	10 pz	€ 760,00
PRM06-0055	MASK40 PC1 130	130	10 pz	€ 770,00

Kit 1 MANDRINO / CHUCK + 6 PINZE / COLLET

n° 1 Mandrino **SK**

n° 6 Pinze Ø 2/3/4/5/6/8

n° 1 Chiave di bloccaggio

Cod. PROMO

Prezzo / Price

PRM06-0056 (070)

€ 145,00

PRM06-0057 (100)

€ 145,00

PRM06-0058 (130)

€ 145,00

# Mandrini MASK40 PC2

ISO40 DIN 69871

Mandrino Portapinza di Precisione / Precision Collet Holder

**SET**

**SOLO  
MANDRINI  
CHUCKS ONLY**

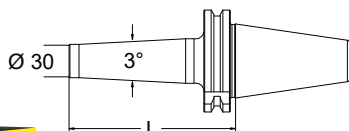

AcquaStream  
by COMAND TOOL



**KIT**

**1 MANDRINO  
+  
7 PINZE  
1 CHUCK + 7 COLLETS**



Composizione Set / Set Composition

Cod. PROMO	Articolo / Item	L	Q.ty	Prezzo / Price
PRM06-0059	MASK40 PC2 070	70	3 pz	€ 290,00
PRM06-0060	MASK40 PC2 100	100	3 pz	€ 300,00
PRM06-0061	MASK40 PC2 130	130	3 pz	€ 310,00
PRM06-0062	MASK40 PC2 070	70	5 pz	€ 420,00
PRM06-0063	MASK40 PC2 100	100	5 pz	€ 430,00
PRM06-0064	MASK40 PC2 130	130	5 pz	€ 440,00
PRM06-0065	MASK40 PC2 070	70	10 pz	€ 750,00
PRM06-0066	MASK40 PC2 100	100	10 pz	€ 760,00
PRM06-0067	MASK40 PC2 130	130	10 pz	€ 770,00

Kit 1 MANDRINO / CHUCK + 7 PINZE / COLLET

n° 1 Mandrino **SK**

n° 7 Pinze Ø 3/4/5/6/8/10/12

n° 1 Chiave di bloccaggio

Cod. PROMO

Prezzo / Price

PRM06-0068 (070)

€ 145,00

PRM06-0069 (100)

€ 145,00

PRM06-0070 (130)

€ 145,00



# Mandrini MAHS63 PC1

# HSK63 DIN 69893

Mandrino Portapinza di Precisione / Precision Collet Holder

**SET**

**SOLO  
MANDRINI  
CHUCKS ONLY**

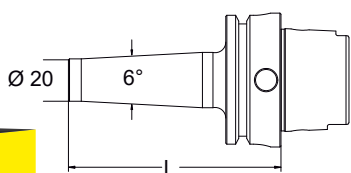

AcquaStream  
by COMAND TOOL



**KIT**

**1 MANDRINO  
+  
6 PINZE  
1 CHUCK + 6 COLLETS**



Composizione Set / Set Composition

Cod. PROMO	Articolo / Item	L	Q.ty	Prezzo / Price
PRM06-0071	MAHS63 PC1 100	100	3 pz	€ 350,00
PRM06-0072	MAHS63 PC1 130	130	3 pz	€ 350,00
PRM06-0073	MAHS63 PC1 160	160	3 pz	€ 350,00
PRM06-0074	MAHS63 PC1 100	100	5 pz	€ 510,00
PRM06-0075	MAHS63 PC1 130	130	5 pz	€ 510,00
PRM06-0076	MAHS63 PC1 160	160	5 pz	€ 510,00
PRM06-0077	MAHS63 PC1 100	100	10 pz	€ 940,00
PRM06-0078	MAHS63 PC1 130	130	10 pz	€ 940,00
PRM06-0079	MAHS63 PC1 160	160	10 pz	€ 940,00

Kit 1 MANDRINO / CHUCK + 6 PINZE / COLLET

n° 1 Mandrino HSK

n° 6 Pinze Ø 2/3/4/5/6/8

n° 1 Chiave di bloccaggio

Cod. PROMO

Prezzo / Price

PRM06-0080 (100)

€ 160,00

PRM06-0081 (130)

€ 160,00

PRM06-0082 (160)

€ 160,00

# Mandrini MAHS63 PC2

# HSK63 DIN 69893

Mandrino Portapinza di Precisione / Precision Collet Holder

**SET**

**SOLO  
MANDRINI  
CHUCKS ONLY**

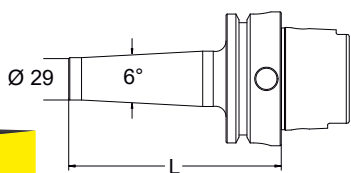

AcquaStream  
by COMAND TOOL



**KIT**

**1 MANDRINO  
+  
7 PINZE  
1 CHUCK + 7 COLLETS**



Composizione Set / Set Composition

Cod. PROMO	Articolo / Item	L	Q.ty	Prezzo / Price
PRM06-0083	MAHS63 PC2 110	110	3 pz	€ 350,00
PRM06-0084	MAHS63 PC2 130	130	3 pz	€ 350,00
PRM06-0085	MAHS63 PC2 160	160	3 pz	€ 350,00
PRM06-0086	MAHS63 PC2 110	110	5 pz	€ 510,00
PRM06-0087	MAHS63 PC2 130	130	5 pz	€ 510,00
PRM06-0088	MAHS63 PC2 160	160	5 pz	€ 510,00
PRM06-0089	MAHS63 PC2 110	110	10 pz	€ 940,00
PRM06-0090	MAHS63 PC2 130	130	10 pz	€ 940,00
PRM06-0091	MAHS63 PC2 160	160	10 pz	€ 940,00

Kit 1 MANDRINO / CHUCK + 7 PINZE / COLLET

n° 1 Mandrino HSK

n° 7 Pinze Ø 3/4/5/6/8/10/12

n° 1 Chiave di bloccaggio

Cod. PROMO

Prezzo / Price

PRM06-0092 (110)

€ 160,00

PRM06-0093 (130)

€ 160,00

PRM06-0094 (160)

€ 160,00

# Mandrini MAC06 PC1

Poligonale C06

Mandrino Portapinza di Precisione - Attacco Poligonale / Precision Collet Holder - Polygonal Shank

**SET**

**SOLO  
MANDRINI  
CHUCKS ONLY**

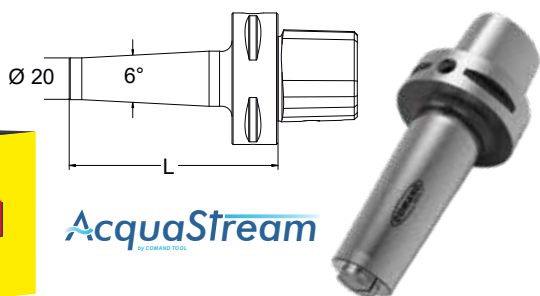

AcquaStream  
by COMAND TOOL

**KIT**

**1 MANDRINO  
+  
6 PINZE  
1 CHUCK + 6 COLLETS**



Composizione Set / Set Composition

Cod. PROMO	Articolo / Item	L	Q.ty	Prezzo / Price
PRM06-0095	MAC06 PC1 100	100	3 pz	€ 350,00
PRM06-0096	MAC06 PC1 130	130	3 pz	€ 350,00
PRM06-0097	MAC06 PC1 160	160	3 pz	€ 350,00
PRM06-0098	MAC06 PC1 100	100	5 pz	€ 510,00
PRM06-0099	MAC06 PC1 130	130	5 pz	€ 510,00
PRM06-0100	MAC06 PC1 160	160	5 pz	€ 510,00
PRM06-0101	MAC06 PC1 100	100	10 pz	€ 940,00
PRM06-0102	MAC06 PC1 130	130	10 pz	€ 940,00
PRM06-0103	MAC06 PC1 160	160	10 pz	€ 940,00

Kit 1 MANDRINO / CHUCK + 6 PINZE / COLLET

n° 1 Mandrino C06

n° 6 Pinze Ø 2/3/4/5/6/8

n° 1 Chiave di bloccaggio

Cod. PROMO

Prezzo / Price

PRM06-0104 (100)

€ 160,00

PRM06-0105 (130)

€ 160,00

PRM06-0106 (160)

€ 160,00

# Mandrini MAC06 PC2

Poligonale C06

Mandrino Portapinza di Precisione - Attacco Poligonale / Precision Collet Holder - Polygonal Shank

**SET**

**SOLO  
MANDRINI  
CHUCKS ONLY**



AcquaStream  
by COMAND TOOL

**KIT**

**1 MANDRINO  
+  
7 PINZE  
1 CHUCK + 7 COLLETS**



Composizione Set / Set Composition

Cod. PROMO	Articolo / Item	L	Q.ty	Prezzo / Price
PRM06-0107	MAC06 PC2 110	110	3 pz	€ 350,00
PRM06-0108	MAC06 PC2 130	130	3 pz	€ 350,00
PRM06-0109	MAC06 PC2 160	160	3 pz	€ 350,00
PRM06-0110	MAC06 PC2 110	110	5 pz	€ 510,00
PRM06-0111	MAC06 PC2 130	130	5 pz	€ 510,00
PRM06-0112	MAC06 PC2 160	160	5 pz	€ 510,00
PRM06-0113	MAC06 PC2 110	110	10 pz	€ 940,00
PRM06-0114	MAC06 PC2 130	130	10 pz	€ 940,00
PRM06-0115	MAC06 PC2 160	160	10 pz	€ 940,00

Kit 1 MANDRINO / CHUCK + 7 PINZE / COLLET

n° 1 Mandrino C06

n° 7 Pinze Ø 3/4/5/6/8/10/12

n° 1 Chiave di bloccaggio

Cod. PROMO

Prezzo / Price

PRM06-0116 (110)

€ 160,00

PRM06-0117 (130)

€ 160,00

PRM06-0118 (160)

€ 160,00

# Smontaconi

## DIN 69871 BT-HSK

Smontaconi Attacco Standard / Assembly Support Standard Shank

Sistema di bloccaggio a 45°/135° / Lock System 45°/135°



**NUOVO CORPO IN ALLUMINIO  
NEW ALUMINUM BODY**



Cod. PROMO	Articolo / Item	Descrizione / Description	Q.tà / Q.ty	Prezzo / Price
<b>PRM14-0001</b>	SMT-CN30	Smontaconi per Mandrini ISO30 e BT30	1	<b>€ 249,00</b>
<b>PRM14-0002</b>	SMT-CN40	Smontaconi per Mandrini ISO40 e BT40	1	<b>€ 249,00</b>
<b>PRM14-0003</b>	SMT-CN50	Smontaconi per Mandrini ISO50 e BT50	1	<b>€ 279,00</b>
<b>PRM14-0004</b>	SMT-HSK63	Smontaconi per Mandrini HSK63	1	<b>€ 269,00</b>
<b>PRM14-0005</b>	SMT-HSK100	Smontaconi per Mandrini HSK100	1	<b>€ 289,00</b>

# Smontaconi

## Attacco Poligonale

Smontaconi Attacco Poligonale / Assembly Support Polygonal Shank



**NUOVO ATTACCO  
NEW SHANK  
POLYGONAL "C"  
DIN ISO 26623-1**



Cod. PROMO	Articolo / Item	Descrizione / Description	Q.tà / Q.ty	Prezzo / Price
<b>PRM14-0006</b>	SMT-C04	Smontaconi per Mandrini Poligonali "C" 04	1	<b>€ 279,00</b>
<b>PRM14-0007</b>	SMT-C05	Smontaconi per Mandrini Poligonali "C" 05	1	<b>€ 279,00</b>
<b>PRM14-0008</b>	SMT-C06	Smontaconi per Mandrini Poligonali "C" 06	1	<b>€ 279,00</b>





Tavole Girevoli 4° Asse / Rotary Table 4th axis



Tavole Girevoli 4°/5° Asse / Rotary Table 4th/5th axis



Tavole Girevoli a trasmissione Direct Drive  
Direct Drive transmission Rotary Table



Tavole Girevoli per microforatrici  
EDM microdrilling Rotary Table



Applicazioni Speciali / Special Application



Contropunte e Controsupporti / Tailstock and Support



**25**  
PROMO

**Easy Line**

Comand Tool annual promotions



*finest metalworking solutions*



Alte di Montecchio Maggiore (Vi) - Viale P. Ceccato, 66/72  
Telefono 0444602661 - e-mail: ferutal@ferutal.it