

# INSERTI PPU + VORTEX BAR

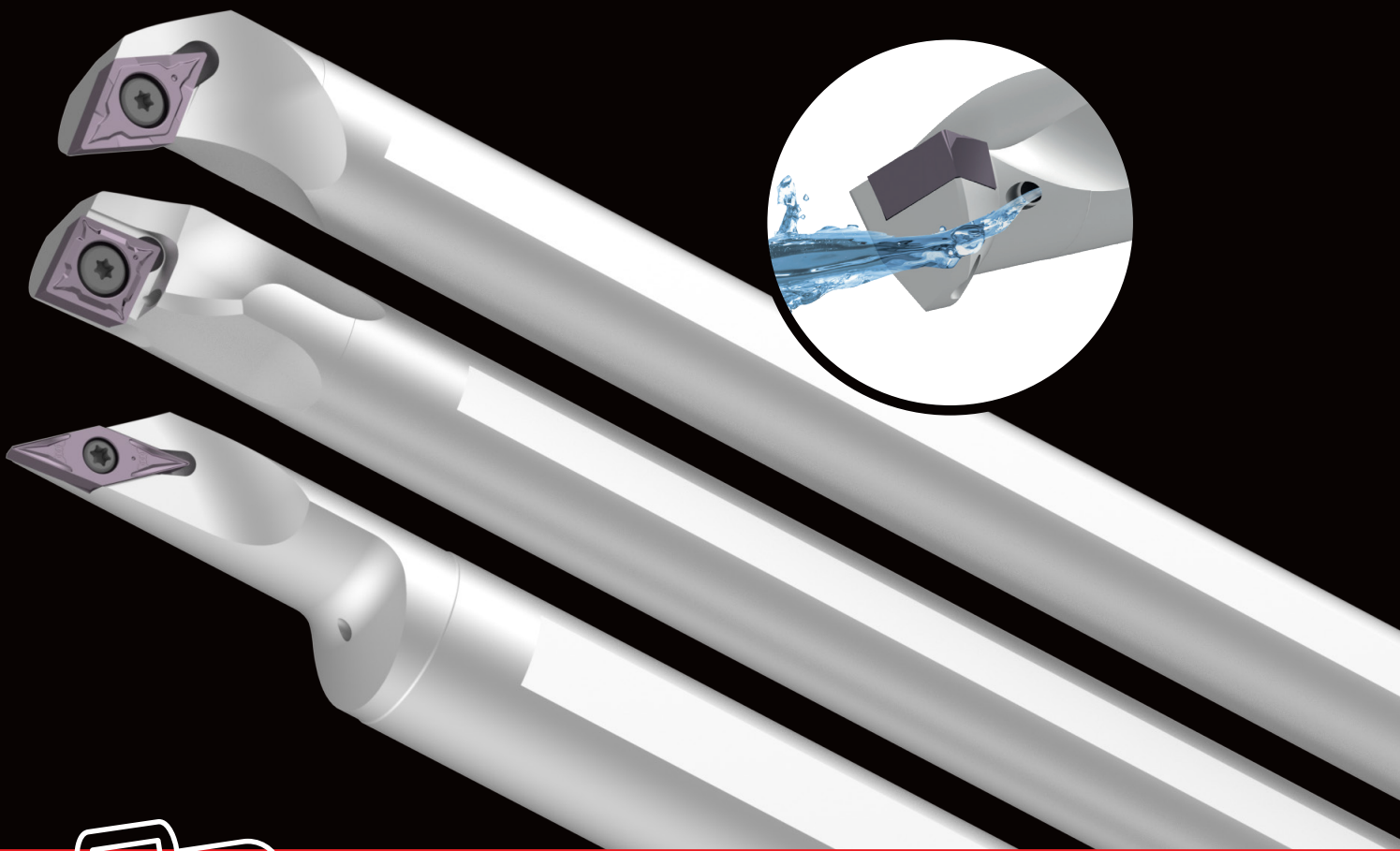

**SPECIAL**  
**KIT Action**



Alte di Montecchio Maggiore (Vi) - Viale P. Ceccato, 66/72  
Telefono 0444602661 - e-mail: ferutal@ferutal.it

**Inserti PPU con Vortex Bar**  
**Kit per barenatura di precisione**  
**(inclusa finitura con taglio interrotto**  
**e barenatura pareti sottili)**

**nikko**TOOLS  
SORMA CUTTING SOLUTIONS

# INSERTI PPU CON VORTEX BAR











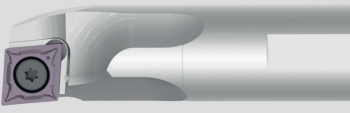

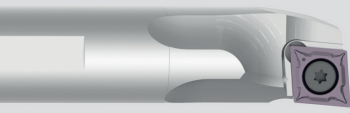

**nikko**TOOLS  
SORMA CUTTING SOLUTIONS

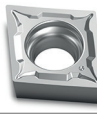
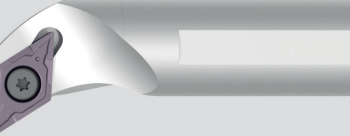
**SPECIAL  
KIT**

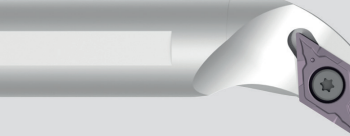

## Prova Vortex Bar + inserti PPU!

Ogni kit contiene 4 Vortex Bar e 10 inserti PPU

<h1>R</h1>   <p>DMIN</p>	1 x NT-V10K-SCLCR06-12 (Ø10)	<p>INTERNAL COOLANT</p> 	12
	1 x NT-V12M-SCLCR06-14 (Ø12)		14
	1 x NT-V16Q-SCLCR09-18 (Ø16)		18
	1 x NT-V20R-SCLCR09-22 (Ø20)		22
	 <p>5 x CCGT060204-PPU 5 x CCGT09T304-PPU</p> <p><b>JP5125</b> U-VORTEX-CC01R</p>		
<h1>L</h1>   <p>DMIN</p>	1 x NT-V10K-SCLCL06-12 (Ø10)	<p>INTERNAL COOLANT</p> 	12
	1 x NT-V12M-SCLCL06-14 (Ø12)		14
	1 x NT-V16Q-SCLCL09-18 (Ø16)		18
	1 x NT-V20R-SCLCL09-22 (Ø20)		22
	 <p>5 x CCGT060204-PPU 5 x CCGT09T304-PPU</p> <p><b>JP5125</b> U-VORTEX-CC01L</p>		
<h1>R</h1>   <p>DMIN</p>	1 x NT-V10K-SDUCR07-14 (Ø10)	<p>INTERNAL COOLANT</p> 	14
	1 x NT-V12M-SDUCR07-16 (Ø12)		16
	1 x NT-V16Q-SDUCR11-23 (Ø16)		23
	1 x NT-V20R-SDUCR11-27 (Ø20)		27
	 <p>5 x DCGT070204-PPU 5 x DCGT11T304-PPU</p> <p><b>JP5125</b> U-VORTEX-DC01R</p>		
<h1>L</h1>   <p>DMIN</p>	1 x NT-V10K-SDUCL07-14 (Ø10)	<p>INTERNAL COOLANT</p> 	14
	1 x NT-V12M-SDUCL07-16 (Ø12)		16
	1 x NT-V16Q-SDUCL11-23 (Ø16)		23
	1 x NT-V20R-SDUCL11-27 (Ø20)		27
	 <p>5 x DCGT070204-PPU 5 x DCGT11T304-PPU</p> <p><b>JP5125</b> U-VORTEX-DC01L</p>		

# INSERTI PPU CON VORTEX BAR





**nikko**TOOLS  
SORMA CUTTING SOLUTIONS



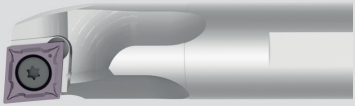

**239,00**  
euro



## Prova Vortex Bar + inserti PPU!

Ogni kit contiene 3 Vortex Bar e 10 inserti PPU





<b>R</b>			INTERNAL COOLANT 	10
	1 x NT-V08H-SCLCR06-10 (Ø8)	DMIN		12
	1 x NT-V10K-SCLCR06-12 (Ø10)			14
	1 x NT-V12M-SCLCR06-14 (Ø12)			
	10 x CCGT060204-PPU	<b>JP5125</b>	U-VORTEX-3CCR	





<b>L</b>			INTERNAL COOLANT 	10
	1 x NT-V08H-SCLCL06-10 (Ø8)	DMIN		12
	1 x NT-V10K-SCLCL06-12 (Ø10)			14
	1 x NT-V12M-SCLCL06-14 (Ø12)			
	10 x CCGT060204-PPU	<b>JP5125</b>	U-VORTEX-3CCL	

**299,00**  
euro



Ogni kit contiene 2 Vortex Bar e 10 inserti PPU

<b>R</b>			INTERNAL COOLANT 	25
	1 x NT-V20R-SVJBR11-25 (Ø20)	DMIN		30
	1 x NT-V25S-SVJBR11-30 (Ø25)			
	10 x VCGT110304-PPU	<b>JP5125</b>	U-VORTEX-VC01R	

<b>L</b>			INTERNAL COOLANT 	25
	1 x NT-V20R-SVJBL11-25 (Ø20)	DMIN		30
	1 x NT-V25S-SVJBL11-30 (Ø25)			
	10 x VCGT110304-PPU	<b>JP5125</b>	U-VORTEX-VC01L	

## Perché scegliere Vortex Bar?

- Migliora l'evacuazione del truciolo
- Riduce le vibrazioni anche ad elevate sporgenze (max 5xD)
- Canali di refrigerazione interna nell'intera gamma

## Perché scegliere inserti PPU?

- Geometria con basse forze di taglio, affidabile, non deforma i pezzi e riduce le vibrazioni nelle operazioni di barenatura
- Grado resistente al calore, specifico per inox e super leghe, affidabilità costante
- Combinazione ottimizzata della geometria e del grado per affrontare molteplici sfide, come la barenatura interrotta di precisione di pareti sottili
- Soluzione universale, dalle lavorazioni più esigenti a quelle convenzionali



Alte di Montecchio Maggiore (Vi) - Viale P. Ceccato, 66/72  
Telefono 0444602661 - e-mail: ferutal@ferutal.it

[www.nikkotools.com](http://www.nikkotools.com)



\$NKKITPPU+ITA